



Canon

IXUS 125 HS
IXUS 127 HS

Camera User Guide

- Before use, be sure to read this guide, including the safety precautions.
- This guide will familiarize you with how to use the camera correctly.
- Keep the guide handy for future reference.

ENGLISH

Package Contents

Before use, make sure the following items are included in the package. If anything is missing, contact your camera dealer.

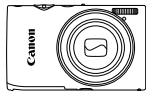

Camera



Battery Pack NB-11L
(with terminal cover)

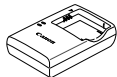

Battery Charger
CB-2LD/CB-2LDE

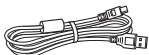

Interface Cable IFC-400PCU



Wrist Strap WS-800



Getting Started



DIGITAL CAMERA
Solution Disk



Warranty System
Booklet

- A memory card is not included (p. 2).

User Manuals

For information about the included software, refer to the *ImageBrowser EX User Guide*, on the DIGITAL CAMERA Manuals Disk (p. 25).



- Adobe Reader is required to view the PDF manuals. Microsoft Word/Word Viewer can be installed to view the Word manuals (required only for manuals for the Middle East).

Compatible Memory Cards

The following memory cards (sold separately) can be used, regardless of capacity.

- SD memory cards*
- SDHC memory cards*
- SDXC memory cards* 
- Eye-Fi cards

* Conforms to SD specifications. However, not all memory cards have been verified to work with the camera.

About Eye-Fi Cards

This product is not guaranteed to support Eye-Fi card functions (including wireless transfer). In case of an issue with an Eye-Fi card, please check with the card manufacturer.

Also note that an approval is required to use Eye-Fi cards in many countries or regions. Without approval, use of the card is not permitted. If it is unclear whether the card has been approved for use in the area, please check with the card manufacturer.



- Always confirm beforehand that memory cards are supported on other devices such as card readers and computers (including the current version of your operating system).

Preliminary Notes and Legal Information

- Take and review some test shots initially to make sure the images were recorded correctly. Please note that Canon Inc., its subsidiaries and affiliates, and its distributors are not liable for any consequential damages arising from any malfunction of a camera or accessory, including memory cards, that results in the failure of an image to be recorded or to be recorded in a way that is machine readable.
- Images recorded by the camera are intended for personal use. Refrain from unauthorized recording that infringes on copyright law, and note that even for personal use, photography may contravene copyright or other legal rights at some performances or exhibitions, or in some commercial settings.
- For information on your camera's warranty, please refer to the Warranty information provided with your camera.
For Canon Customer Support, please refer to the warranty information for contact information.
- Although the LCD monitor is produced under extremely high-precision manufacturing conditions and more than 99.99% of the pixels meet design specifications, in rare cases some pixels may be defective or may appear as red or black dots. This does not indicate camera damage or affect recorded images.
- The LCD monitor may be covered with a thin plastic film for protection against scratches during shipment. If covered, remove the film before using the camera.
- When the camera is used over an extended period, it may become warm. This does not indicate damage.

Part Names and Conventions in This Guide

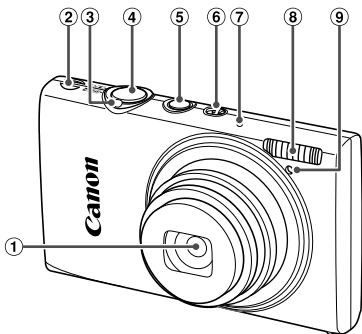





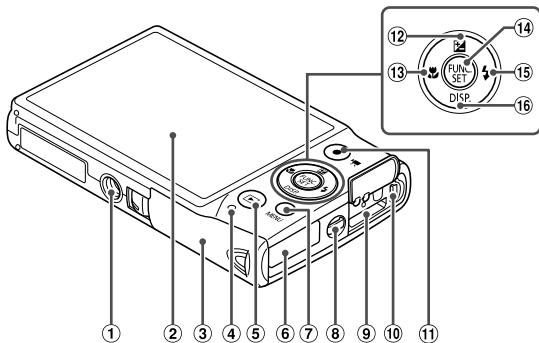

- | | |
|--|------------------|
| ① Lens | ④ Shutter button |
| ② Speaker | ⑤ ON/OFF button |
| ③ Zoom lever | ⑥ Mode switch |
| Shooting: [T] (telephoto) / [W] (wide angle) | ⑦ Microphone |
| Playback: Q (magnify) / [] (index) | ⑧ Flash |
| | ⑨ Lamp |

- ⓘ : Important information you should know
- ✎ : Notes and tips for expert camera use
- (p. xx): Pages with related information (in this example, “xx” represents a page number)
- Instructions in this guide apply to the camera under default settings.
- For convenience, all supported memory cards are simply referred to as “the memory card”.
- The tabs shown above titles indicate whether the function is used for still images, movies, or both.

Still Images : Indicates that the function is used when shooting or viewing still images.

Movies : Indicates that the function is used when shooting or viewing movies.



- | | |
|---|---|
| ① Tripod socket | ⑩ AV OUT (Audio/video output) / DIGITAL terminal |
| ② Screen (LCD monitor) | ⑪ Movie button |
| ③ Memory card/battery cover | ⑫  (Exposure compensation) / Up button |
| ④ Indicator | ⑬  (Macro) / Left button |
| ⑤  (Playback) button | ⑭  FUNC./SET button |
| ⑥ DC coupler cable port | ⑮  (Flash) / Right button |
| ⑦ MENU button | ⑯ DISP. (Display) / Down button |
| ⑧ Strap mount | |
| ⑨ HDMI™ terminal | |

- In this guide, icons are used to represent the corresponding camera buttons and switches on which they appear or which they resemble.
- The following camera buttons are represented by icons.
 - ▲ Up button ⑫ on back
 - ◀ Left button ⑬ on back
 -  FUNC./SET button ⑭ on back
 - ▶ Right button ⑮ on back
 - ▼ Down button ⑯ on back
- On-screen text is indicated in brackets.

Contents

| | | | |
|--|-----------|--|------------|
| Package Contents | 2 | Special Modes for Other Purposes | 95 |
| Compatible Memory Cards | 2 | Shooting Various Movies | 103 |
| Preliminary Notes and Legal Information | 3 | | |
| Part Names and Conventions in This Guide | 4 | | |
| Contents | 6 | 4 P mode | 105 |
| Contents: Basic Operations | 8 | Shooting in Program AE Mode (P Mode) | 106 |
| Safety Precautions | 10 | Image Brightness (Exposure Compensation) | 107 |
| Initial Preparations | 13 | Color and Continuous Shooting ... | 110 |
| Trying the Camera Out | 20 | Shooting Range and Focusing | 114 |
| Included Software, Manuals | 25 | Flash | 121 |
| Accessories | 31 | Other Settings | 123 |
| Specifications | 32 | | |
| | | 5 Playback Mode | 125 |
| 1 Camera Basics | 37 | Viewing | 126 |
| On/Off | 38 | Browsing and Filtering Images | 130 |
| Shutter Button | 39 | Editing Face ID Information | 133 |
| Shooting Modes | 39 | Image Viewing Options | 135 |
| Shooting Display Options | 40 | Protecting Images | 139 |
| FUNC. Menu | 41 | Erasing Images | 143 |
| MENU Menu | 42 | Rotating Images | 146 |
| Indicator Display | 43 | Image Categories | 148 |
| Clock | 43 | Editing Still Images | 152 |
| | | Editing Movies | 157 |
| 2 Smart Auto Mode | 45 | | |
| Shooting in Smart Auto Mode | 46 | 6 Setting Menu | 159 |
| Common, Convenient Features | 55 | Adjusting Basic Camera Functions | 160 |
| Using Face ID | 61 | | |
| Image Customization Features | 71 | 7 Accessories | 171 |
| Helpful Shooting Features | 76 | Tips on Using Included Accessories | 172 |
| Customizing Camera Operation | 79 | Optional Accessories | 173 |
| | | Using Optional Accessories | 175 |
| 3 Other Shooting Modes | 81 | Printing Images | 181 |
| Specific Scenes | 82 | | |
| Applying Special Effects | 86 | | |

| | | | |
|---------------------------|------------|---------------------------------|-----|
| Using an Eye-Fi Card..... | 194 | Handling Precautions | 201 |
| <hr/> | | On-Screen Messages..... | 202 |
| 8 Appendix..... | 197 | On-Screen Information..... | 204 |
| Troubleshooting | 198 | Functions and Menu Tables | 208 |
| | | Index..... | 216 |

Contents: Basic Operations



Shoot

- Use camera-determined settings (Auto Mode)..... 46

Shooting people well



Portraits
(p. 82)



Against Snow
(p. 83)



Smooth Skin
(p. 85)

Matching specific scenes



Night Scenes
(p. 82)



Low Light
(p. 83)



Under Water
(p. 83)

Applying special effects



Vivid Colors
(p. 86)



Poster Effect
(p. 86)



Fish-Eye Effect
(p. 87)



Miniature Effect
(p. 88)



Toy Camera Effect
(p. 89)



Soft Focus
(p. 90)



Monochrome
(p. 91)

- Focus on faces 46, 82, 116
- Without using the flash (Flash Off) 58
- With myself in the shot (Self-Timer)..... 56, 98
- Add the shooting date and time (Date Stamp)..... 59
- Use Face ID..... 61, 133
- Movie clips and photos together (Movie Digest)..... 95

**View**

- View images (Playback Mode) 126
- Automatic playback (Slideshow)..... 136
- On a TV 175
- On a computer..... 26
- Browse through images quickly 130
- Erase images..... 143

**Shoot/View Movies**

- Shoot movies 46, 103
- View movies 126
- Fast-moving subjects, slow-motion playback 103

**Print**

- Print pictures..... 181

**Save**

- Save images to a computer 26

Safety Precautions

- Before using the product, please ensure that you read the safety precautions described below. Always ensure that the product is used correctly.
- The safety precautions noted on the following pages are intended to prevent injuries to yourself and other persons, or damage to the equipment.
- Be sure to also check the guides included with any separately sold accessories you use.



Warning

Denotes the possibility of serious injury or death.

- **Do not trigger the flash in close proximity to people's eyes.**

Exposure to the intense light produced by the flash could damage eyesight. In particular, remain at least one meter (39 inches) away from infants when using the flash.

- **Store this equipment out of the reach of children and infants.**

Strap: Putting the strap around a child's neck could result in asphyxiation.

- **Use only recommended power sources.**
- **Do not attempt to disassemble, alter or apply heat to the product.**
- **Avoid dropping or subjecting the product to severe impacts.**
- **To avoid the risk of injury, do not touch the interior of the product if it has been dropped or otherwise damaged.**
- **Stop using the product immediately if it emits smoke, a strange smell, or otherwise behaves abnormally.**
- **Do not use organic solvents such as alcohol, benzine, or thinner to clean the product.**
- **Do not let the product come into contact with water (e.g. sea water) or other liquids.**
- **Do not allow liquids or foreign objects to enter the camera.**

This could result in electrical shock or fire.

If liquids or foreign objects come into contact with the camera interior, immediately turn the camera off and remove the battery.

If the battery charger becomes wet, unplug it from the outlet and consult your camera distributor or a Canon Customer Support Help Desk.

- **Use only the recommended battery.**
- **Do not place the battery near or in direct flame.**
- **Unplug the power cord periodically, and using a dry cloth, wipe away any dust and dirt that has collected on the plug, the exterior of the power outlet, and the surrounding area.**
- **Do not handle the power cord with wet hands.**
- **Do not use the equipment in a manner that exceeds the rated capacity of the electrical outlet or wiring accessories. Do not use if the power cord or plug are damaged, or not fully plugged into the outlet.**
- **Do not allow dirt or metal objects (such as pins or keys) to contact the terminals or plug.**

The battery may explode or leak, resulting in electrical shock or fire. This could cause injury and damage the surroundings. In the event that a battery leaks and the battery electrolyte contacts eyes, mouth, skin or clothing, immediately flush with water.

- **Turn the camera off in places where camera use is prohibited.**

The electromagnetic waves emitted by the camera may interfere with the operation of electronic instruments and other devices. Exercise adequate caution when using the camera in places where use of electronic devices is restricted, such as inside airplanes and medical facilities.

- **Do not play the supplied CD-ROM(s) in any CD player that does not support data CD-ROMs.**

It is possible to suffer hearing loss from listening with headphones to the loud sounds of a CD-ROM played on an audio CD player (music player). Additionally, this could damage the speakers.



Caution

Denotes the possibility of injury.

- **When holding the camera by the strap, be careful not to bang it, subject it to strong impacts or shocks, or let it get caught on other objects.**
- **Be careful not to bump or push strongly on the lens.**

This could lead to injury or damage the camera.

- **Be careful not to subject the screen to strong impacts.**

If the screen cracks, injury may result from the broken fragments.

- **When using the flash, be careful not to cover it with your fingers or clothing.**

This could result in burns or damage to the flash.

- **Avoid using, placing or storing the product in the following places:**

- Places subject to strong sunlight
- Places subject to temperatures above 40 °C (104 °F)
- Humid or dusty areas

These could cause leakage, overheating or an explosion of the battery, resulting in electrical shock, fire, burns or other injuries.

High temperatures may cause deformation of the camera or battery charger casing.

- **Viewing images on the camera screen for prolonged periods may cause discomfort.**

Caution

Denotes the possibility of damage to the equipment.

- **Do not aim the camera at bright light sources (such as the sun on a clear day).** Doing so may damage the image sensor.

- **When using the camera on a beach or at a windy location, be careful not to allow dust or sand to enter the camera.**

This may cause the product to malfunction.

Safety Precautions

- **In regular use, small amounts of smoke may be emitted from the flash.**

This is due to the high intensity of the flash burning dust and foreign materials stuck to the front of the unit. Please use a cotton swab to remove dirt, dust or other foreign matter from the flash to prevent heat build-up and damage to the unit.

- **Remove and store the battery when you are not using the camera.**

If the battery is left inside the camera, damage caused by leakage may occur.

- **Before you discard the battery, cover the terminals with tape or other insulators.**

Contacting other metal materials may lead to fire or explosions.

- **Unplug the battery charger from the power outlet after charging is complete, or when you are not using it.**

- **Do not place anything, such as cloth, on top of the battery charger while it is charging.**

Leaving the unit plugged in for a long period of time may cause it to overheat and distort, resulting in fire.

- **Do not place the battery near pets.**

Pets biting the battery could cause leakage, overheating or explosion, resulting in fire or damage.

- **Do not sit down with the camera in your pocket.**

Doing so may cause malfunctions or damage the screen.

- **When putting the camera in your bag, ensure that hard objects do not come into contact with the screen.**

- **Do not attach any hard objects to the camera.**

Doing so may cause malfunctions or damage the screen.

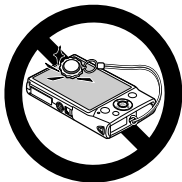

Initial Preparations

Prepare for shooting as follows.

Attaching the Strap

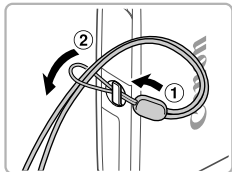

- Thread the end of the strap through the strap hole (①), and then pull the other end of the strap through the loop on the threaded end (②).

Holding the Camera



- Place the strap around your wrist.
- When shooting, keep your arms close to your body and hold the camera securely to prevent it from moving. Do not rest your fingers on the flash.

Charging the Battery

Before use, charge the battery with the included charger. Be sure to charge the battery initially, because the camera is not sold with the battery charged.

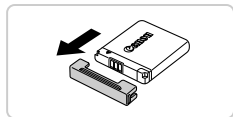

1 Remove the cover.

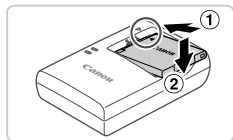

2 Insert the battery.

- After aligning the ▲ marks on the battery and charger, insert the battery by pushing it in (①) and down (②).

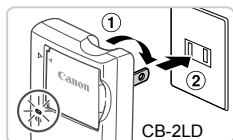

3 Charge the battery.

- **For CB-2LD:** Flip out the plug (①) and plug the charger into a power outlet (②).
 - **For CB-2LDE:** Plug the power cord into the charger, then plug the other end into a power outlet.
- ▶ The charging lamp turns orange and charging begins.
- ▶ When the charging is finished, the lamp turns green.

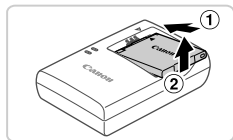
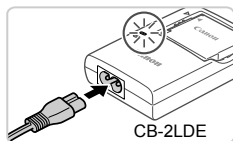

4 Remove the battery.

- After unplugging the battery charger, remove the battery by pushing it in (①) and up (②).

- ❗ • To protect the battery and keep it in optimal condition, do not charge it continuously for more than 24 hours.
- For battery chargers that use a power cord, do not attach the charger or cord to other objects. Doing so could result in malfunction or damage to the product.



- For details on charging time and the number of shots and recording time possible with a fully charged battery, see “Specifications” (p. 32).

Inserting the Battery and Memory Card

Insert the included battery and a memory card (sold separately). Note that before using a new memory card (or a memory card formatted in another device), you should format the memory card with this camera (p. 164).

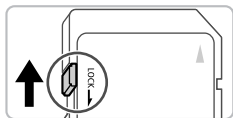

1 Check the card's write-protect tab.

- Recording is not possible on memory cards with a write-protect tab when the tab is in the locked (downward) position. Slide the tab up until it clicks into the unlocked position.

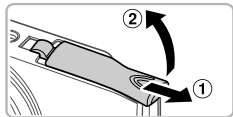

2 Open the cover.

- Slide the cover (①) and open it (②).

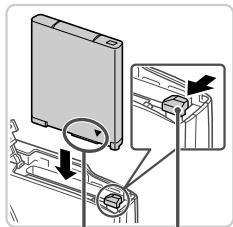

3 Insert the battery.

- While pressing the battery lock in the direction of the arrow, insert the battery facing as shown and push it in until it clicks into the locked position.
- Batteries inserted facing the wrong way cannot be locked into the correct position. Always confirm that the battery is facing the right way and locks when inserted.

Terminals Battery Lock

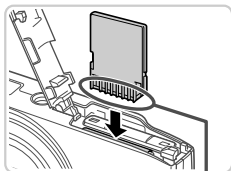

Terminals

4 Insert the memory card.

- Insert the memory card facing as shown until it clicks into the locked position.
- Make sure the memory card is facing the right way when you insert it. Inserting memory cards facing the wrong way may damage the camera.

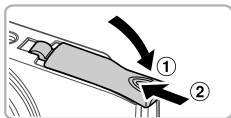

5 Close the cover.

- Lower the cover (①) and hold it down as you slide it, until it clicks into the closed position (②).

Removing the Battery and Memory Card

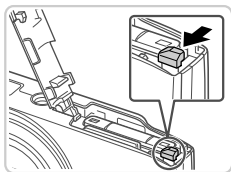

Remove the battery.

- Open the cover and press the battery lock in the direction of the arrow.
- ▶ The battery will pop up.

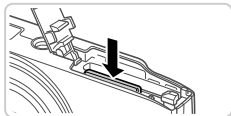

Remove the memory card.

- Push the memory card in until it clicks, and then slowly release it.
- ▶ The memory card will pop up.

Setting the Date and Time

A screen for setting the date and time is displayed the first time you turn the camera on. Be sure to specify the date and time, which is the basis for dates and times added to your images.

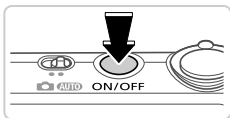

1 Turn the camera on.

- Press the ON/OFF button.
- ▶ The [Date/Time] screen is displayed.

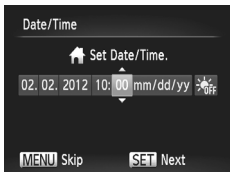

2 Set the date and time.

- Press the ◀▶ buttons to choose an option.
- Press the ▲▼ buttons to specify the date and time.
- When finished, press the  button.

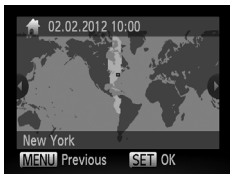

3 Set the local time zone.

- Press the ◀▶ buttons to choose your local time zone.

4 Finish the setup process.

- Press the  button when finished. After a confirmation message, the setting screen is no longer displayed.
- To turn off the camera, press the ON/OFF button.



- ⚠ Unless you set the date, time, and local time zone, the [Date/Time] screen will be displayed each time you turn the camera on. Specify the correct information.

-  To set daylight saving time (1 hour ahead), choose ☀_{OFF} in step 2 and then choose ☀ by pressing the ▲▼ buttons.

▼ Changing the Date and Time

Adjust the date and time as follows.

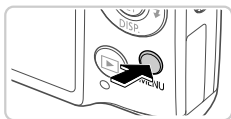

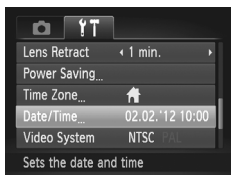

1 Access the camera menu.

- Press the **MENU** button.



2 Choose [Date/Time].

- Move the zoom lever to choose the  tab.
- Press the ▲▼ buttons to choose [Date/Time], and then press the  button.

3 Change the date and time.

- Follow step 2 on p. 17 to adjust the settings.
- Press the **MENU** button to close the menu.



-  Date/time settings can be retained for about 3 weeks by the camera's built-in date/time battery (backup battery) after the battery pack is removed.
- The date/time battery will be charged in about 4 hours once you insert a charged battery or connect the camera to an AC adapter kit (sold separately, p. 173), even if the camera is left off.
- Once the date/time battery is depleted, the [Date/Time] screen will be displayed when you turn the camera on. Follow the steps on p. 17 to set the date and time.

Display Language

The display language can be changed as needed.

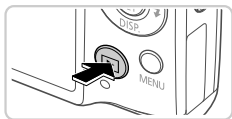

1 Enter Playback mode.

- Press the **▶** button.



2 Access the setting screen.

- Press and hold the **FUNC SET** button, and then immediately press the **MENU** button.

| | | |
|-------------|-----------|---------|
| English | Suomi | Magyar |
| Deutsch | Norsk | Türkçe |
| Français | Svenska | 繁體中文 |
| Nederlands | Español | 한국어 |
| Dansk | 简体中文 | മലയാളം |
| Italiano | Русский | العربية |
| Українська | Português | Română |
| B. Malaysia | Ελληνικά | فارسی |
| Indonesian | Polski | हिन्दी |
| Tiếng Việt | Čeština | 日本語 |

3 Set the display language.

- Press the **▲▼▶◀** buttons to choose a language, and then press the **FUNC SET** button.
- ▶ Once the display language has been set, the setting screen is no longer displayed.



- A clock icon is displayed if you wait too long in step 2 after pressing the **FUNC SET** button before you press the **MENU** button. In this case, press the **FUNC SET** button to dismiss the clock icon and repeat step 2.
- You can also change the display language by pressing the **MENU** button and choosing [Language ↑↑ tab.

Trying the Camera Out

Follow these instructions to turn the camera on, shoot still images or movies, and then view them.

Shooting (Smart Auto)

For fully automatic selection of the optimal settings for specific scenes, simply let the camera determine the subject and shooting conditions.

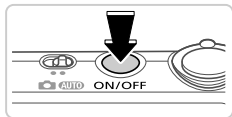

1 Turn the camera on.

- Press the ON/OFF button.
- ▶ The startup screen is displayed.



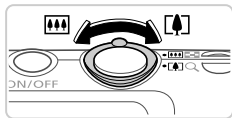

2 Enter **AUTO** mode.

- Set the mode switch to **AUTO**.
- Aim the camera at the subject. As the camera determines the scene, it will make a slight clicking noise.
- ▶ Icons representing the scene and image stabilization mode are displayed in the upper right of the screen.
- ▶ Frames displayed around any subjects that are detected indicate that they are in focus.



3 Compose the shot.

- To zoom in and enlarge the subject, move the zoom lever toward  (telephoto), and to zoom away from the subject, move it toward  (wide angle).

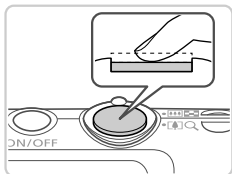

4 Shoot.

Shooting Still Images

① Focus.

- Press the shutter button lightly, halfway down. The camera beeps twice after focusing, and AF frames are displayed to indicate image areas in focus.



AF Frames

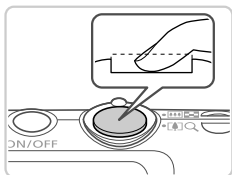

② Shoot.

- Press the shutter button all the way down.
- ▶ As the camera shoots, a shutter sound is played, and in low-light conditions, the flash fires automatically.
- ▶ Keep the camera still until the shutter sound ends.
- ▶ Your shot remains displayed on the screen for about two seconds.
- Even while the shot is displayed, you can take another shot by pressing the shutter button again.

Shooting Movies

① Start shooting.

- Press the movie button. The camera beeps once as recording begins, and [●Rec] is displayed with the elapsed time.

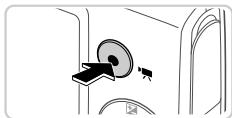

Trying the Camera Out

Elapsed Time

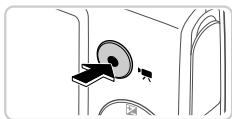

- ▶ Black bars displayed on the top and bottom edges of the screen indicate image areas not recorded.
- ▶ Frames displayed around any faces that are detected indicate that they are in focus.
- Once recording begins, you can take your finger off the movie button.

② Finish shooting.

- Press the movie button again to stop shooting. The camera beeps twice as recording stops.
- ▶ Recording will stop automatically when the memory card becomes full.

Viewing

After shooting images or movies, you can view them on the screen as follows.

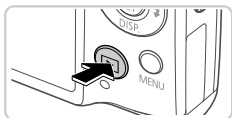



1 Enter Playback mode.

- Press the  button.
- ▶ Your last shot is displayed.





2 Browse through your images.



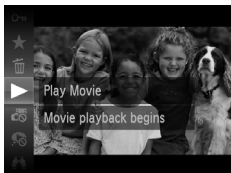

- To view the previous image, press the  button. To view the next image, press the  button.





- To access Scroll Display mode, press and hold the ◀▶ buttons for at least one second. In this mode, press the ◀▶ buttons to browse through images.
- To return to single-image display, press the  button.
- To browse images grouped by shooting date, press the ▲▼ buttons in Scroll Display mode.
- Movies are identified by a  icon. To play movies, go to step 3.

3 Play movies.

- Press the  button, press the ▲▼ buttons to choose , and then press the  button again.
- Playback now begins, and after the movie is finished,  is displayed.
- To adjust the volume, press the ▲▼ buttons during playback.



- To switch to Shooting mode from Playback mode, press the shutter button halfway.

Erasing the Images





You can choose and erase unneeded images one by one. Be careful when erasing images, because they cannot be recovered.



1 Choose an image to erase.

- Press the ◀▶ buttons to choose an image.

2 Erase the image.

- Press the  button, press the ▲▼ buttons to choose , and then press the  button again.
- After [Erase?] is displayed, press the ◀▶ buttons to choose [Erase], and then press the  button.
- ▶ The current image is now erased.
- To cancel erasure, press the ◀▶ buttons to choose [Cancel], and then press the  button.



- You can also erase all images at once (p. 143).

Included Software, Manuals

The software and the manuals on the included CD-ROMs are introduced below, with instructions for installation, saving images to a computer, and using the manuals.

Features of the Included Software

After installing the software on the CD-ROM, you can do the following things on your computer.

ImageBrowser EX

- Import images and change camera settings
- Manage images: view, search, and organize
- Print and edit images
- Update to the latest software version with the auto update function

Auto Update Function

Using the included software, you can update to the latest version, and download new functions via the Internet (some software excluded). Be sure to install the software on a computer with an Internet connection so you can use this function.



- Internet access is required to use this function, and any ISP account charges and access fees must be paid separately.
- This function may not be available depending on the camera or region you live in.

Manuals

The following manuals are provided on the DIGITAL CAMERA Manuals Disk.

Camera User Guide

Once you are familiar with the information in *Getting Started*, refer to this for a more in-depth understanding of camera operation.

ImageBrowser EX User Guide

Refer to this guide when using the included software.

This guide can be referenced from the ImageBrowser EX Help function.



- Depending on the country or region where you purchased your camera, the *ImageBrowser EX User Guide* may not be accessible from the Help function. In such cases, it will either be included on the CD-ROM bundled with your camera, or you can download the latest version from the Canon website.

System Requirements

The included software can be used on the following computers.

Windows

| | |
|----------------------|--|
| Operating System | Windows 7 SP1 Windows Vista SP2 Windows XP SP3 |
| Computer | Computers running one of the above operating systems (preinstalled), with an included USB port and Internet connection |
| Processor | Still images: 1.6 GHz or higher, Movies: Core 2 Duo 2.6 GHz or higher |
| RAM | Windows 7 (64 bit): 2 GB or more Windows 7 (32 bit), Windows Vista (64 bit, 32 bit): 1 GB or more (still images), 2 GB or more (movies) Windows XP: 512 MB or more (still images), 2 GB or more (movies) |
| Interfaces | USB |
| Free Hard Disk Space | 440 MB or more* |
| Display | 1024 x 768 resolution or higher |

* In Windows XP, Microsoft .NET Framework 3.0 or later (max. 500 MB) must be installed. Installation may take some time, depending on computer performance.

Macintosh

| | |
|----------------------|--|
| Operating System | Mac OS X 10.6 |
| Computer | Computers running one of the above operating systems (preinstalled), with an included USB port and Internet connection |
| Processor | Still images: Core Duo 1.83 GHz or higher, Movies: Core 2 Duo 2.6 GHz or higher |
| RAM | 1 GB or more (still images), 2 GB or more (movies) |
| Interfaces | USB |
| Free Hard Disk Space | 550 MB or more |
| Display | 1024 x 768 resolution or higher |



- Check the Canon website for the latest system requirements, including supported OS versions.

Installing the Software

Windows 7 and Mac OS X 10.6 are used here for the sake of illustration. Using the software auto update function, you can update to the latest version and download new functions via the Internet (some software excluded), so be sure to install the software on a computer with an Internet connection.

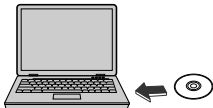

1 Insert the CD-ROM in the computer's CD-ROM drive.

- Insert the included CD-ROM (DIGITAL CAMERA Solution Disk) (p. 2) in the computer's CD-ROM drive.
- On a Macintosh computer, after inserting the disc, double-click the desktop disc icon to open it, and then double-click the  icon displayed.



2 Begin the installation.

- Click [Easy Installation] and follow the on-screen instructions to complete the installation process.

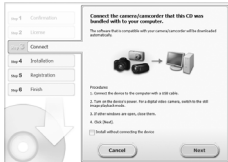

3 When a message is displayed prompting you to connect the camera, connect it to a computer.

- With the camera turned off, open the cover (①). With the smaller plug of the included interface cable (p. 2) in the orientation shown, insert the plug fully into the camera terminal (②).

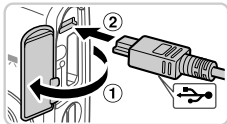

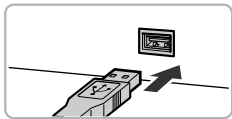

- Insert the larger plug of the interface cable in the computer's USB port. For details about USB connections on the computer, refer to the computer user manual.

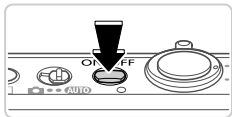

4 Install the files.

- Turn the camera on, and follow the on-screen instructions to complete the installation process.
- ▶ The software will connect to the Internet to update to the latest version and download new functions. Installation may take some time, depending on computer performance and the Internet connection.
- Click [Finish] or [Restart] on the screen after installation and remove the CD-ROM when the desktop is displayed.
- Turn the camera off and disconnect the cable.



- When not connected to the Internet, there are the following limitations.
 - The screen in step 3 will not be displayed.
 - Some functions may not be installed.
 - The first time you connect the camera to the computer, drivers will be installed, so it may take a few minutes until camera images are accessible.
- If you have several cameras that were bundled with ImageBrowser EX on the included CD-ROMs, be sure to use each camera with their included CD-ROM and follow the on-screen installation instructions for each. Doing so will ensure that each camera will receive the correct updates and new functions via the auto update function.

Saving Images to a Computer



Windows 7 and Mac OS X 10.6 are used here for the sake of illustration.

1 Connect the camera to the computer.

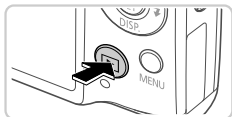
- Follow step 3 on p. 27 to connect the camera to a computer.



2 Turn the camera on to access CameraWindow.

- Press the  button to turn the camera on.
- On a Macintosh computer, CameraWindow is displayed when a connection is established between the camera and computer.
- For Windows, follow the steps introduced below.
- In the screen that displays, click the  link to modify the program.



- Choose [Downloads Images From Canon Camera using Canon CameraWindow] and then click [OK].

- Double click .

CameraWindow

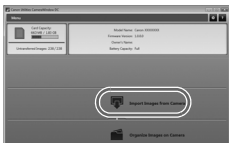

3 Save the images to the computer.

- Click [Import Images from Camera], and then click [Import Untransferred Images].
- ▶ Images are now saved to the Pictures folder on the computer, in separate folders named by date.
- After images are saved, close CameraWindow, press the  button to turn the camera off, and unplug the cable.
- For instructions on viewing images on a computer, refer to the *ImageBrowser EX User Guide*.



- In Windows 7, if the screen in step 2 is not displayed, click the  icon in the taskbar.
- To start CameraWindow in Windows Vista or XP, click [Downloads Images From Canon Camera using Canon CameraWindow] on the screen displayed when you turn the camera on in step 2. If CameraWindow is not displayed, click the [Start] menu and choose [All Programs] ▶ [Canon Utilities] ▶ [CameraWindow] ▶ [CameraWindow].
- On a Macintosh computer, if CameraWindow is not displayed after step 2, click the [CameraWindow] icon in the Dock (the bar at the bottom of the desktop).
- Although you can save images to a computer simply by connecting your camera to the computer without using the included software, the following limitations apply.
 - It may take a few minutes after you connect the camera to the computer until camera images are accessible.
 - Images shot in vertical orientation may be saved in horizontal orientation.
 - Image protection settings may be cleared from images saved to a computer.
 - Some problems may occur when saving images or image information, depending on the operating system version, the software in use, or image file sizes.
 - Some functions provided by the included software may not be available, such as editing movies or returning images to the camera.

Accessories

Included Accessories



Wrist Strap
WS-800



Battery Pack
NB-11L*
(with terminal cover)



Battery Charger
CB-2LD/
CB-2LDE*



DIGITAL CAMERA
Solution Disk

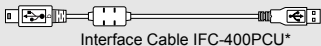

Interface Cable IFC-400PCU*

Power



AC Adapter Kit
ACK-DC90

Cable

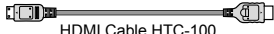

HDMI Cable HTC-100



AV Cable AVC-DC400



Memory Card



Card Reader



Windows/
Macintosh
Computer



TV/Video
System

Flash Unit



High-Power Flash HF-DC2

Case



Waterproof Case
WP-DC330L

Canon PictBridge- Compatible Printers

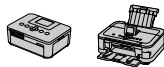

* Also available for purchase separately.

Use of genuine Canon accessories is recommended.

This product is designed to achieve excellent performance when used with genuine Canon accessories. Canon shall not be liable for any damage to this product and/or accidents such as fire, etc., caused by the malfunction of non-genuine Canon accessories (e.g., a leakage and/or explosion of a battery pack). Please note that this warranty does not apply to repairs arising out of the malfunction of non-genuine Canon accessories, although you may request such repairs on a chargeable basis.

Specifications

| | |
|---------------------------------------|---|
| Camera Effective Pixels | Approx. 16.1 million pixels |
| Lens Focal Length | 5x zoom: 4.3 (W) – 21.5 (T) mm (35mm film equivalent: 24 (W) – 120 (T) mm) |
| LCD Monitor | 7.5 cm (3.0 in.) color TFT LCD Effective Pixels: Approx. 461,000 dots |
| File Formats | Design rule for Camera File system, DPOF (version 1.1) compliant |
| Data Types | Still Images: Exif 2.3 (JPEG) Movies: MOV (H.264 video data, Linear PCM (2 channel monaural) audio data) |
| Interfaces | Hi-speed USB HDMI output Analog audio output (monaural) Analog video output (NTSC/PAL) |
| Power | Battery Pack NB-11L AC Adapter Kit ACK-DC90 |
| Dimensions (Based on CIPA Guidelines) | 93.2 x 57.0 x 20.0 mm (3.67 x 2.24 x 0.79 in.) |
| Weight (Based on CIPA Guidelines) | Approx. 135 g (approx. 4.76 oz.; including batteries and memory card) Approx. 120 g (approx. 4.23 oz.; camera body only) |

Number of Shots/Recording Time, Playback Time









| | |
|-------------------------------|--------------------|
| Number of Shots | Approx. 170 |
| Movie Recording Time*1 | Approx. 30 minutes |
| Continuous Shooting*2 | Approx. 1 hour |
| Playback Time | Approx. 3 hours |

*1 Time under default camera settings, when normal operations are performed, such as shooting, pausing, turning the camera on and off, and zooming.

*2 Time available when shooting the maximum movie length (until recording stops automatically) repeatedly.

- The number of shots that can be taken is based on measurement guidelines of the Camera & Imaging Products Association (CIPA).
- Under some shooting conditions, the number of shots and recording time may be less than mentioned above.
- Number of shots/recording time with fully charged batteries.



Number of 4:3 Shots per Memory Card

| Resolution (Pixels) | Compression Ratio | No. Shots per Memory Card (Approx.) | |
|--------------------------------------|---|-------------------------------------|--------|
| | | 8 GB | 32 GB |
| L (Large) 16M/4608x3456 |  | 1131 | 4567 |
| |  | 1903 | 7684 |
| M1 (Medium 1) 8M/3264x2448 |  | 2252 | 9094 |
| |  | 3721 | 15020 |
| M2 (Medium 2) 2M/1600x1200 |  | 7442 | 30040 |
| |  | 12927 | 52176 |
| S (Small) 0.3M/640x480 |  | 27291 | 110150 |
| |  | 40937 | 165225 |

• These values are measured according to Canon standards and may change depending on the subject, memory card and camera settings.



• Table values are based on images with a 4:3 aspect ratio. Changing the aspect ratio (see p. 71) will enable more shots, because less data is used per image than for 4:3 images. However, with **M2**, 16:9 images have a resolution of 1920 x 1080 pixels, which requires more data than for 4:3 images.

Recording Time per Memory Card



| Image Quality | Recording Time per Memory Card | |
|---|--------------------------------|-------------------------------------|
| | 8 GB | 32 GB |
|  | 29 min. 39 sec. | 1 hr. 59 min. 43 sec. |
|  | 42 min. 11 sec.* ¹ | 2 hr. 50 min. 19 sec.* ² |
|  | 1 hr. 28 min. 59 sec. | 5 hr. 59 min. 10 sec. |

*1 Approx. 27 min. 39 sec. for iFrame movies (see p. 104).





*2 Approx. 1 hr. 51 min. 37 sec. for iFrame movies (see p. 104).

- These values are measured according to Canon standards and may change depending on the subject, memory card and camera settings.
- Recording will automatically stop when the file size of an individual clip being recorded reaches 4 GB, or when the recording time reaches approximately 10 minutes (for  or  movies) or approximately 1 hour (for  movies).
- On some memory cards, recording may stop before the maximum clip length has been reached. Speed Class 6 or higher memory cards are recommended.

Flash Range

| | |
|--|-------------------------------|
| Maximum wide angle ( | 50 cm – 3.5 m (1.6 – 11 ft.) |
| Maximum telephoto ( | 90 cm – 2.0 m (3.0 – 6.6 ft.) |

Shooting Range

| Shooting Mode | Focusing Range | Maximum Wide Angle ( | Maximum Telephoto ( |
|---------------|---|---|--|
| AUTO | – | 3 cm (1.2 in.) – infinity | 90 cm (3.0 ft.) – infinity |
| Other modes |  | 5 cm (2.0 in.) – infinity | 90 cm (3.0 ft.) – infinity |
| |  * | 3 – 50 cm (1.2 in. – 1.6 ft.) | – |
| |  * | 3 m (9.8 ft.) – infinity | 3 m (9.8 ft.) – infinity |

* Not available in some shooting modes.

Continuous Shooting Speed

| Shooting Mode | Speed |
|---|------------------------|
|  | Approx. 5.8 shots/sec. |
| P | Approx. 2.0 shots/sec. |

Shutter Speed

| | |
|---|------------------|
| AUTO mode, automatically set range | 1 – 1/2000 sec. |
| Range in all shooting modes | 15 – 1/2000 sec. |

Aperture

| | |
|----------|-------------------------------------|
| f/number | f/2.7 / f/8.0 (W), f/5.9 / f/17 (T) |
|----------|-------------------------------------|

Battery Pack NB-11L

| | |
|-----------------------|---|
| Type | Rechargeable lithium-ion battery |
| Rated Voltage | 3.6 V DC |
| Rated Capacity | 680 mAh |
| Charging Cycles | Approx. 300 times |
| Operating Temperature | 0 – 40 °C (32 – 104 °F) |
| Dimensions | 34.6 x 40.2 x 5.2 mm (1.36 x 1.58 x 0.20 in.) |
| Weight | Approx. 13 g (approx. 0.46 oz.) |

Battery Charger CB-2LD/CB-2LDE

| | |
|-----------------------|---|
| Rated Input | 100 V – 240 V AC (50/60 Hz) |
| Rated Output | 4.2 V DC, 0.41 A |
| Charging Time | Approx. 2 hours (when using NB-11L) |
| Charge Indicator | Charging: orange / Fully charged: green (two-indicator system) |
| Operating Temperature | 5 – 40 °C (41 – 104 °F) |
| Dimensions | 85.0 x 57.6 x 24.3 mm (3.35 x 2.27 x 0.96 in.) |
| Weight | Approx. 59 g (approx. 2.08 oz.) (CB-2LD) Approx. 56 g (approx. 1.98 oz.) (CB-2LDE, excluding power cord) |

- All data is based on tests by Canon.
- Camera specifications or appearance are subject to change without notice.

1

Camera Basics

Basic camera operations and features

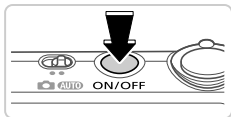



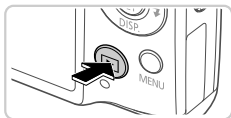

Shooting Mode

- Press the ON/OFF button to turn the camera on and prepare for shooting.
- To turn the camera off, press the ON/OFF button again.



Playback Mode

- Press the  button to turn the camera on and view your shots.
- To turn the camera off, press the  button again.

- 
- To switch to Playback mode from Shooting mode, press the  button.
 - To switch to Shooting mode from Playback mode, press the shutter button halfway (p. 39).
 - The lens will be retracted after about one minute once the camera is in Playback mode. You can turn the camera off when the lens is retracted by pressing the  button.

Power-Saving Features (Auto Power Down)

As a way to conserve battery power, the camera automatically deactivates the screen and then turns itself off after a specific period of inactivity.

Power Saving in Shooting Mode

The screen is automatically deactivated after about one minute of inactivity. In about two more minutes, the lens is retracted and the camera turns itself off. To activate the screen and prepare for shooting when the screen is off but the lens is still out, press the shutter button halfway (p. 39).

Power Saving in Playback Mode

The camera turns itself off automatically after about five minutes of inactivity.

- 
- You can deactivate these power-saving features if you prefer (p. 167).
 - You can also adjust the timing of screen deactivation (p. 167).

Shutter Button

To ensure your shots are in focus, always press the shutter button lightly (halfway) initially. Once the subject is in focus, press the button all the way down to shoot.

In this manual, shutter button operations are described as pressing the button *halfway* or *all the way down*.

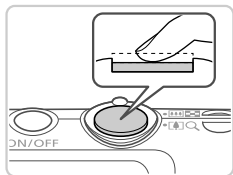

1 Press halfway. (Press lightly to focus.)

- Press the shutter button halfway. The camera beeps twice, and AF frames are displayed around image areas in focus.

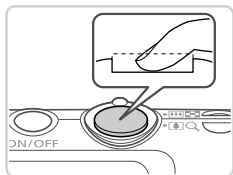

2 Press all the way down. (From the halfway position, press fully to shoot.)

- ▶ The camera shoots, as a shutter sound is played.
- Keep the camera still until the shutter sound ends.

- ! Images may be out of focus if you shoot without initially pressing the shutter button halfway.
- Length of shutter sound playback varies depending on the time required for the shot. It may take longer in some shooting scenes, and images will be blurry if you move the camera (or the subject moves) before the shutter sound ends.

Shooting Modes

Use the mode switch to access each shooting mode.



← Fully automatic shooting, with camera-determined settings (p. 46).



← Shoot with optimal settings for specific scenes (p. 82), or take a variety of shots using your preferred settings (p. 105).

Shooting Display Options

Press the ▼ button to view other information on the screen, or to hide the information. For details on the information displayed, see p. 204.



Information is displayed



No information is displayed



- Screen brightness is automatically increased by the night display function when you are shooting under low light, making it easier to check how shots are composed. However, on-screen image brightness may not match the brightness of your shots. Note that any on-screen image distortion or jerky subject motion will not affect recorded images.
- For playback display options, see p. 128.

FUNC. Menu

Configure commonly used functions through the FUNC. menu as follows. Note that menu items and options vary depending on the shooting mode (pp. 210 – 211) or playback mode (p. 215).

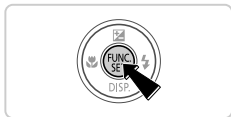



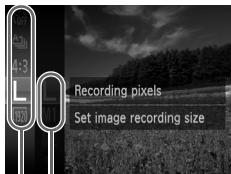

1 Access the FUNC. menu.

- Press the  button.





2 Choose a menu item.

- Press the  buttons to choose a menu item, and then press the  or  button.
- In some menu items, functions can be specified simply by pressing the  or  button, or another screen is displayed for configuring the function.

Menu Items





3 Choose an option.

- Press the  buttons to choose an option.
- Options labeled with a  icon can be configured by pressing the **MENU** button.
- To return to the menu items, press the  button.



4 Finish the setup process.

- Press the  button.
- ▶ The screen before you pressed the  button in step 1 is displayed again, showing the option you configured.



- To undo any accidental setting changes, you can restore the camera's default settings (p. 170).

MENU Menu

Configure a variety of camera functions through other menus as follows. Menu items are grouped by purpose on tabs, such as shooting (📷), playback (▶), and so on. Note that available settings vary depending on the selected shooting or playback mode (pp. 212 – 215).

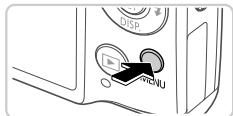

1 Access the menu.

- Press the **MENU** button.



2 Choose a tab.

- Move the zoom lever or press the ◀▶ buttons to choose a tab.

3 Choose a setting.

- Press the ▲▼ buttons to choose a setting.
- To choose settings with options not shown, first press the FUNC SET or ▶ button to switch screens, and then press the ▲▼ buttons to select the setting.

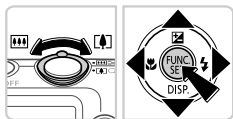

4 Choose an option.

- Press the ◀▶ buttons to choose an option.

5 Finish the setup process.

- Press the **MENU** button to return to the screen displayed before you pressed the **MENU** button in step 1.

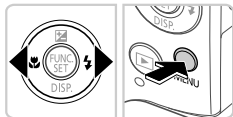

- To undo any accidental setting changes, you can restore the camera's default settings (p. 170).

Indicator Display

The indicator on the back of the camera (p. 5) lights up or blinks depending on the camera status.



| Color | Indicator Status | Camera Status |
|-------|------------------|--|
| Green | On | Connected to a computer (p. 29), or display off |
| | Blinking | Starting up, recording/reading/transmitting images, or shooting long exposures (p. 99) |

- ! When the indicator blinks green, never turn the camera off, open the memory card/battery cover, or shake or jolt the camera, which may corrupt images or damage the camera or memory card.

Clock

You can check the current time.



- Press and hold the  button.
- ▶ The current time appears.
- If you hold the camera vertically while using the clock function, it will switch to vertical display. Press the  buttons to change the display color.
- Press the  button again to cancel the clock display.



- When the camera is off, press and hold the  button, then press the ON/OFF button to display the clock.

2

Smart Auto Mode

Convenient mode for easy shots with greater control over shooting

Shooting in Smart Auto Mode

For fully automatic selection at optimal settings for specific scenes, simply let the camera determine the subject and shooting conditions.

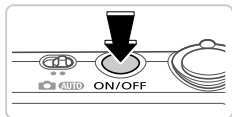

1 Turn the camera on.

- Press the ON/OFF button.
- ▶ The startup screen is displayed.



2 Enter **AUTO** mode.

- Set the mode switch to **AUTO**.
- Aim the camera at the subject. The camera will make a slight clicking noise as it determines the scene.
- ▶ Icons representing the scene and image stabilization mode are displayed in the upper right of the screen (pp. 51, 53).
- ▶ Frames displayed around any detected subjects indicate that they are in focus.



3 Compose the shot.

- To zoom in and enlarge the subject, move the zoom lever toward [🌲] (telephoto), and to zoom away from the subject, move it toward [🌳] (wide angle). (A zoom bar showing the zoom position is displayed.)



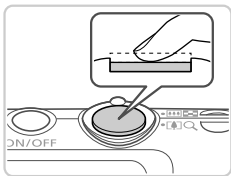

AF Frames

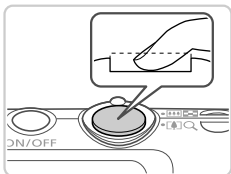

4 Shoot.

Shooting Still Images

① Focus.

- Press the shutter button halfway. The camera beeps twice after focusing, and AF frames are displayed to indicate image areas in focus.
- Several AF frames are displayed when multiple areas are in focus.

② Shoot.

- Press the shutter button all the way down.
- ▶ As the camera shoots, a shutter sound is played, and in low-light conditions, the flash fires automatically.
- Keep the camera still until the shutter sound ends.
- ▶ Your shot remains displayed on the screen for about two seconds.
- Even while the shot is displayed, you can take another shot by pressing the shutter button again.

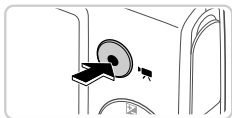

Elapsed Time

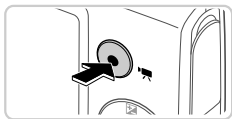
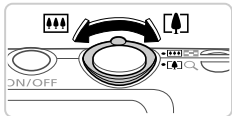

Shooting Movies

① Start shooting.

- Press the movie button. The camera beeps once as recording begins, and [●Rec] is displayed with the elapsed time.
- ▶ Black bars displayed on the top and bottom edges of the screen indicate image areas not recorded.
- ▶ Frames displayed around any faces that are detected indicate that they are in focus.
- Once recording begins, you can take your finger off the movie button.





② Resize the subject and recompose the shot as needed.

- To resize the subject, do the same thing as in step 3 on p. 46. However, note that the sound of camera operations will be recorded.
- When you recompose shots, the focus, brightness, and colors will be automatically adjusted.





③ Finish shooting.

- Press the movie button again to stop shooting. The camera beeps twice as recording stops.
- Recording will stop automatically when the memory card becomes full.

Still Images/Movies

-  To restore camera sound if you have accidentally deactivated it (by holding the  button down while turning the camera on), press the **MENU** button and choose [Mute] on the  tab, and then press the  buttons to choose [Off].

Still Images

-  A flashing  icon warns that images are more likely to be blurred by camera shake. In this case, attach the camera to a tripod or take other measures to keep it still.
 - If your shots are dark despite the flash firing, move closer to the subject. For details on the flash range, see “Specifications” (p. 32).
 - The subject may be too close if the camera only beeps once when you press the shutter button halfway. For details on the focusing range (shooting range), see “Specifications” (p. 32).
 - To reduce red-eye and to assist in focusing, the lamp may be activated when shooting in low-light conditions.
 - A blinking  icon displayed when you attempt to shoot indicates that shooting is not possible until the flash has finished recharging. Shooting can resume as soon as the flash is ready, so either press the shutter button all the way down and wait, or release it and press it again.
-
-  The shutter sound will not be played when the Sleeping and Babies (Sleeping) icons (p. 51) are displayed.
 - The flash firing during shots indicates that the camera has automatically attempted to ensure optimal colors in the main subject and background (Multi-area White Balance).

Movies



- The camera may become warm when shooting movies repeatedly over an extended period. This does not indicate damage.

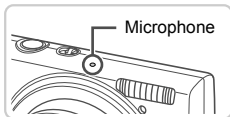

- Keep your fingers away from the microphone while shooting movies. Blocking the microphone may prevent audio from being recorded or may cause the recording to sound muffled.
- Avoid touching camera controls other than the movie button when shooting movies, because sounds made by the camera will be recorded.
- To correct suboptimal image color that may occur in $\overline{1920}$ movie shooting (p. 75) after you recompose shots, press the movie button to stop recording, and then press it again to resume recording.





- Audio recording is monaural.

Scene Icons









In **AUTO** mode, shooting scenes determined by the camera are indicated by the icon displayed, and corresponding settings are automatically selected for optimal focusing, subject brightness, and color. Depending on the scene, continuous images may be shot (p. 52).

| | Background | Normal | Backlit | Dark* | Sunsets | Spotlights |
|-----------------------------|------------|--------|---------|-------|---------|------------|
| Subject | | | | | | |
| People | | | | | – | |
| In Motion | | | | – | – | – |
| Shadows on Face | | | – | – | – | – |
| Smiling | | | | – | – | – |
| Sleeping | | | | – | – | – |
| Babies | | | | – | – | – |
| Smiling | | | | – | – | – |
| Sleeping | | | | – | – | – |
| Children (In Motion) | | | | – | – | – |
| Other Subjects | | | | | | |
| In Motion | | | | – | – | – |
| At Close Range | | | | – | – | |

* When using tripod

-  The background color of icons is light blue when the background is a blue sky, dark blue when the background is dark, and gray for all other backgrounds.
-  The background color of icons is light blue when the background is a blue sky, and gray for all other backgrounds.



Shooting in Smart Auto Mode



- The background color of , , , , and  is dark blue, and the background color of  is orange.
- When shooting movies, only People, Other Subjects, and At Close Range icons will be displayed.
- When shooting with the self-timer, People (In Motion), Smiling, Sleeping, Babies (Smiling), Babies (Sleeping), Children, Other Subjects (In Motion) icons will not be displayed.
- When the drive mode is set to  (p. 113), and when [Hg Lamp Corr.] is set to [On] and scenes are automatically corrected (p. 74), Smiling, Sleeping, Babies (Smiling), Babies (Sleeping), and Children icons will not be displayed.
- If the flash is set to , the Backlit icons for Smiling and Children will not be displayed.
- Babies, Babies (Smiling), Babies (Sleeping), and Children icons will be displayed when [Face ID] is set to [On], and the face of a registered baby (under two years old) or child (from two to twelve years old) is detected (p. 61). Confirm beforehand that the date and time are correct (p. 17).



- Try shooting in **P** mode (p. 105) if the scene icon does not match actual shooting conditions, or if it is not possible to shoot with your expected effect, color, or brightness.

Continuous Shooting Scenes

If you shoot a still image when the following icons are displayed, the camera will shoot continuously. If you press the shutter button halfway when one of the icons in the table below is displayed, one of the following icons will be displayed to inform you that the camera will shoot continuous images: , , or .

| | |
|-----------------------------|--|
| Smiling (including Babies) |  : Consecutive images are captured, and the camera analyzes details such as facial expressions to save the image determined to be the best. |
| Sleeping (including Babies) |  : Beautiful shots of sleeping faces, created by combining consecutive shots to reduce camera shake and image noise. The AF assist beam will not light up, the flash will not fire, and the shutter sound will not be played. |
| Children |  : So you don't miss a photo opportunity of children who move around, the camera will capture three consecutive images for each shot. |

- In some scenes, expected images may not be saved, and images may not look as expected.
- Focus, image brightness, and color are determined by the first shot.











- When you want to shoot single images only, press the  button, choose  in the menu, and then choose .

Image Stabilization Icons

Optimal image stabilization for the shooting conditions is automatically applied (Intelligent IS). Additionally, the following icons are displayed in **AUTO** mode.

| | | | |
|---|---|---|---|
|  | Image stabilization for still images |  | Image stabilization for movies, reducing strong camera shake, as when shooting while walking (Dynamic IS) |
|  | Image stabilization for still images, when panning* |  | Image stabilization for subtle camera shake, such as when shooting movies at telephoto (Powered IS) |
|  | Image stabilization for macro shots (Hybrid IS) |  | No image stabilization, because the camera is mounted on a tripod or held still by other means |

* Displayed when you pan, following moving subjects with the camera. When you follow subjects moving horizontally, image stabilization only counteracts vertical camera shake, and horizontal stabilization stops. Similarly, when you follow subjects moving vertically, image stabilization only counteracts horizontal camera shake.



- To cancel image stabilization, set [IS Mode] to [Off] (p. 123). In this case, an IS icon is not displayed.

On-Screen Frames

A variety of frames are displayed once the camera detects subjects you are aiming the camera at.

- A white frame is displayed around the subject (or person's face) determined by the camera to be the main subject, and gray frames are displayed around other detected faces. Frames follow moving subjects within a certain range to keep them in focus. However, if the camera detects subject movement, only the white frame will remain on the screen.
- When you are pressing the shutter button halfway and the camera detects subject movement, a blue frame is displayed, and the focus and image brightness are constantly adjusted (Servo AF).



- Try shooting in **P** mode (p. 105) if no frames are displayed, if frames are not displayed around desired subjects, or if frames are displayed on the background or similar areas.

Zooming In Closer on Subjects (Digital Zoom)

When distant subjects are too far away to enlarge using the optical zoom, use digital zoom for up to about 20x enlargement.

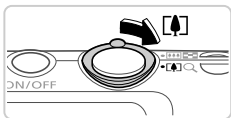

1 Move the zoom lever toward .

- Hold the lever until zooming stops.
- ▶ Zooming stops at the largest possible zoom factor (where the image is not noticeably grainy), which is displayed when you release the zoom lever.

Zoom Factor



2 Move the zoom lever toward again.

- ▶ The camera zooms in even closer on the subject.

- ! Moving the zoom lever will display the zoom bar (which indicates the zoom position). The color of the zoom bar will change depending on the zoom range.
 - White range: optical zoom range where the image will not appear grainy.
 - Yellow range: digital zoom range where the image is not noticeably grainy (ZoomPlus).
 - Blue range: digital zoom range where the image will appear grainy.

Because the blue range will not be available at some resolution settings (p. 72), the maximum zoom factor can be achieved by following step 1.



- Focal length when optical and digital zoom are combined is as follows (35mm film equivalent).
24 – 480 mm (24 – 120 mm with optical zoom alone)
- To deactivate digital zoom, press the **MENU** button, choose [Digital Zoom] on the  tab, and then choose [Off].

Using the Self-Timer

With the self-timer, you can include yourself in group photos or other timed shots. The camera will shoot about 10 seconds after you press the shutter button.



1 Configure the setting.

- Press the **FUNC/SET** button, choose **OFF** in the menu, and then choose the **10** option (p. 41).
- ▶ Once the setting is complete, **10** is displayed.

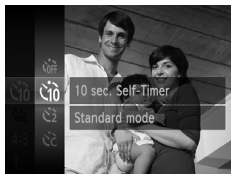

2 Shoot.

- For Still Images: Press the shutter button halfway to focus on the subject, and then press it all the way down.
- For Movies: Press the movie button.
- ▶ Once you start the self-timer, the lamp will blink and the camera will play a self-timer sound.
- ▶ Two seconds before the shot, the blinking and sound will speed up. (The lamp will remain lit in case the flash fires.)
- To cancel shooting after you have triggered the self-timer, press the **MENU** button.
- To restore the original setting, choose **OFF** in step 1.

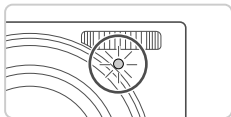

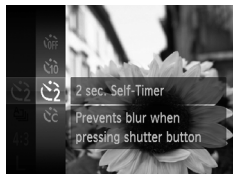

Using the Self-Timer to Avoid Camera Shake

This option delays shutter release until about two seconds after you have pressed the shutter button. If the camera is unsteady while you are pressing the shutter button, it will not affect your shot.



Configure the setting.

- Follow step 1 on p. 56 and choose .
- ▶ Once the setting is complete,  is displayed.
- Follow step 2 on p. 56 to shoot.

Customizing the Self-Timer

You can specify the delay (0 – 30 seconds) and number of shots (1 – 10).

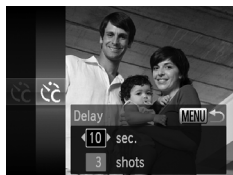

1 Choose .

- Follow step 1 on p. 56, choose , and then press the **MENU** button.

2 Configure the setting.

- Press the **▲▼** buttons to choose [Delay] or [Shots].
- Press the **◀▶** buttons to choose a value, and then press the **FUNC/SET** button.
- ▶ Once the setting is complete,  is displayed.
- Follow step 2 on p. 56 to shoot.



- For movies shot using the self-timer, [Delay] represents the delay before recording begins, but the [Shots] setting has no effect.



- When you specify multiple shots, image brightness and white balance are determined by the first shot. More time is required between shots when the flash fires or when you have specified to take many shots. Shooting will stop automatically when the memory card becomes full.
- When a delay longer than two seconds is specified, two seconds before the shot, the lamp blinking and self-timer sound will speed up. (The lamp will remain lit in case the flash fires.)

Deactivating the Flash

Prepare the camera for shooting without the flash as follows.



Configure the setting.

- Press the ► button, press the ◀▶ buttons to choose ⚡, and then press the FUNC SET button.
- ▶ Once the setting is complete, ⚡ is displayed.
- To restore the original setting, repeat this process but choose ⚡^A.

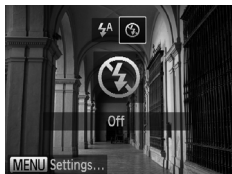

- ! If a flashing ⚡ icon is displayed when you press the shutter button halfway in low-light conditions, mount the camera on a tripod or take other measures to keep it still.

Adding the Shooting Date and Time

The camera can add the shooting date and time to images in the lower-right corner. However, note that these cannot be removed. Confirm beforehand that the date and time are correct (p. 17).

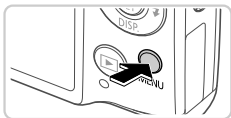

1 Configure the setting.

- Press the **MENU** button, choose [Date Stamp] on the  tab, and then choose the desired option (p. 42).
- ▶ Once the setting is complete, [DATE] is displayed.

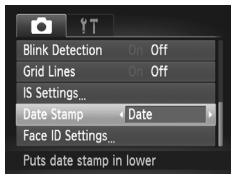

2 Shoot.

- ▶ As you take shots, the camera adds the shooting date or time to the lower-right corner of images.
- To restore the original setting, choose [Off] in step 1.



- Images originally recorded without the date and time can be printed with this information as follows. However, adding the date and time to images that already have this information may cause it to be printed twice.
 - Use camera DPOF print settings (p. 188) to print
 - Use the included software to print
For details, refer to the *ImageBrowser EX User Guide*.
 - Print using printer functions (p. 181)

Choosing Subjects to Focus On (Tracking AF)

Shoot after choosing a subject to focus on as follows.



1 Specify Tracking AF.

- Press the ▲ button.
- ▶ □ is displayed in the center of the screen.



2 Choose a subject to focus on.

- Aim the camera so that □ is on the desired subject, and then press the shutter button halfway.
- ▶ A blue frame is displayed, and the camera will keep the subject in focus and image brightness adjusted (Servo AF).

3 Shoot.

- Press the shutter button all the way down to shoot.
- Press the ▲ button to cancel Tracking AF.



- Tracking may not be possible when subjects are too small or move too rapidly, or when subject color or brightness matches that of the background too closely.

Using Face ID

If you register a person ahead of time, the camera will detect that person's face, and prioritize focus, brightness, and color for that person when shooting. In **AUTO** mode, the camera can detect babies and children based on registered birthdays and optimize settings for them when shooting. This function is also useful when searching for a specific registered person among a large number of images (p. 130).

Personal Information



- Information such as images of a face (face info) registered with Face ID, and personal information (name, birthday) will be saved on the camera. Additionally, when registered people are detected, their names will be recorded in still images. When using the Face ID function, be careful when sharing the camera or images with others, and when posting images online where many others can view them.
- When disposing of a camera or transferring it to another person after using Face ID, be sure to erase all information (registered faces, names, and birthdays) from the camera (p. 69).

Registering Face ID Information

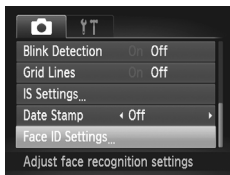
You can register information (face info, name, birthday) for up to 12 people to use with Face ID.



1 Access the setting screen.

- Press the **MENU** button, choose [Face ID Settings] on the  tab, and then press the  button (p. 42).

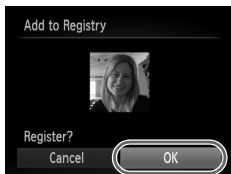
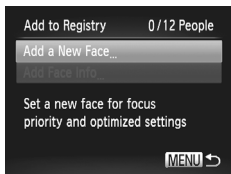
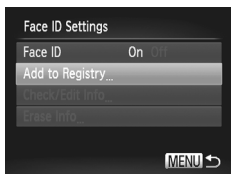

- Choose [Add to Registry], and then choose [Add a New Face].

2 Register face information.

- Aim the camera so that the face of the person you want to register is inside the gray frame at the center of the screen.
- A white frame on the person's face indicates that the face is recognized. Make sure a white frame is displayed on the face, and then shoot.
- If the face is not recognized, you cannot register face information.

3 Save the settings.



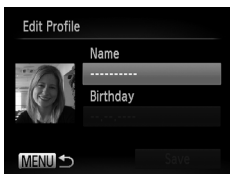



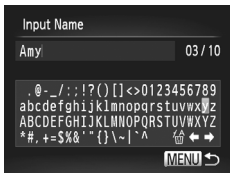



- After [Register?] is displayed, press the ◀▶ buttons to choose [OK], and then press the  button.



► The [Edit Profile] screen is displayed.







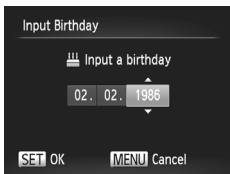



4 Enter a name.

- Press the  button.
- Press the    buttons to choose a character, and then press the  button to enter it.
- Up to 10 characters can be used.
- Choose  or  and press the  button to move the cursor.
- Choose  and press the  button to delete the previous character.
- Press the **MENU** button to return to the edit profile screen.







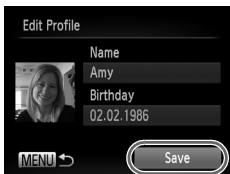

5 Enter a birthday.

- Press the   buttons to choose [Birthday], and then press the  button.
- Press the   buttons to choose an item.
- Press the   buttons to specify the date and time.
- When finished, press the  button.



6 Save the settings.

- Press the   buttons to choose [Save], and then press the  button.
- After a message is displayed, press the   buttons to choose [Yes], and then press the  button.

7 Continue registering face information.

- To register up to 4 more points of face information (expressions or angles), repeat steps 2 – 3.
- Registered faces are more easily recognized if you add a variety of face information. In addition to a head on angle, add a slight side angle, a shot when smiling, and shots inside and outside.



- The flash will not fire when following step 2.
- If you do not register a birthday in step 5, Babies or Children icons (p. 51) will not display in **AUTO** mode.



- You can overwrite registered face info, and add face info later if you have not filled all 5 face info slots (p. 67).

Shooting

If you register a person ahead of time, the camera will prioritize that person as the main subject, and optimize focus, brightness, and color for that person when shooting.



- ▶ When you point the camera toward a subject, the names of up to 3 registered people will be displayed when they are detected.
- Shoot.
- ▶ Displayed names will be recorded in still images. Even if people are detected, but their names are not displayed, the names (up to 5 people) will be recorded in the image.



- People other than those registered may be mistakenly detected as the registered person if they share similar facial features.



- Registered people may not be correctly detected if the captured image or scene differs drastically from the registered face information.
- If a registered face is not detected, or not easily detected, overwrite registered information with new face info. Registering face info right before shooting will allow for easier detection of registered faces.
- If a person is mistakenly detected as another person and you continue shooting, you can edit or erase the name recorded in the image during playback (p. 133).
- Because faces of babies and children change quickly as they grow, you should update their face info regularly (p. 67).
- When information display is set to off (p. 40), names will not display, but will be recorded in the image.
- If you don't want names to be recorded in still images, choose [Face ID Settings] on the tab, choose [Face ID], and then choose [Off].
- You can check names recorded in images in the playback screen (simple information display) (p. 126).

Checking and Editing Registered Information

Checking Registered Face ID Information

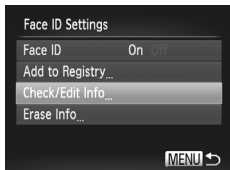



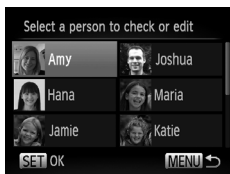

1 Access the [Check/Edit Info] screen.

- Following step 1 on p. 61, choose [Check/Edit Info] and press the  button.



2 Choose a person to check.

- Press the     buttons to choose a person, and then press the  button.

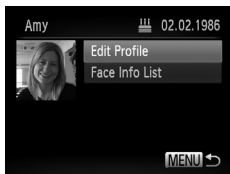

3 Check the registered information.

- Press the   buttons to choose an item, and then press the  button.
- Check the registered information.

Changing the Name or Birthday

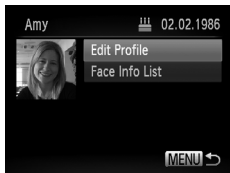

1 Access the [Edit Profile] screen.

- Following steps 1 – 3 on p. 66, choose [Edit Profile] and press the  button.

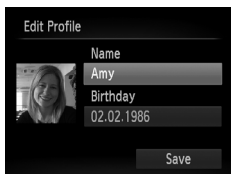

2 Input changes.

- Press the ▲▼ buttons to choose an item, and follow steps 4 – 5 on p. 63 to input changes.



- Even if you change names in [Edit Profile], the names recorded in previously shot images will remain the same.



- You can check and erase registered face information by choosing [Face Info List] on the screen in step 3.
- You can use the included software to edit registered names. Some characters entered with the included software may not display on the camera, but will be correctly recorded in images.

■ Overwriting and Adding Face Information

You can overwrite existing face information with new face info. You should update face information regularly, especially with babies and children, as their faces change quickly as they grow.

You can also add face information when all 5 face info slots have not been filled.



1 Access the [Add Face Info] screen.

- On the screen in step 1 on p. 61, choose [Add Face Info] and press the  button.

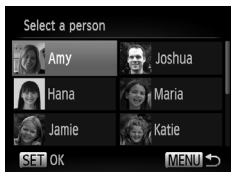

2 Choose the name of the person to overwrite.

- Press the ▲▼◀▶ buttons to choose the name of a person to overwrite, and then press the  button.
- If 4 or less face information slots are registered, follow step 5 on p. 68 to add more face info.



3 Access the face info screen.

- Read the message that displays, press the ◀▶ buttons to choose [OK], and then press the button.
- The face info screen is displayed.

4 Choose the face info to overwrite.

- Press the ▲▼◀▶ buttons to choose the face info to overwrite, and then press the button.

5 Register face information.

- Follow steps 2 – 3 on p. 62 to shoot, and then register the new face information.
- Registered faces are more easily recognized if you add a variety of face information. In addition to a head on angle, add a slight side angle, a shot when smiling, and shots inside and outside.



- You cannot add face information if all 5 information slots are filled. Follow the steps above to overwrite face information.
- You can follow the above steps to register new face info when there is at least one slot open, however you cannot overwrite any face information. Instead of overwriting face info, first erase unwanted existing info (p. 68), and then register new face information (p. 61) as needed.

Erasing Face Information

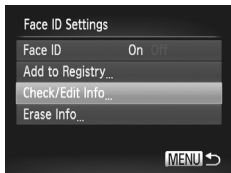

1 Access the [Check/Edit Info] screen.

- Following step 1 on p. 61, choose [Check/Edit Info] and press the button.

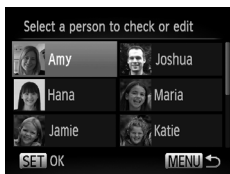

2 Choose the name of the person whose face info you want to erase.

- Press the ▲▼◀▶ buttons to choose the name of the person whose face info you want to erase, and then press the  button.

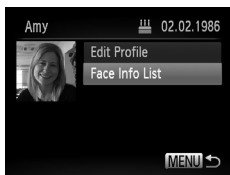

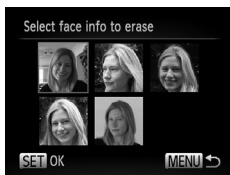

3 Access the [Face Info List] screen.

- Press the ▲▼ buttons to choose [Face Info List], and then press the  button.



4 Choose the face info to erase.

- Press the  button, press the ▲▼◀▶ buttons to choose the face info you want to erase, and then press the  button.
- After [Erase?] is displayed, press the ◀▶ buttons to choose [OK], and then press the  button.
- The selected face info will be erased.

Erasing Registered Information

You can erase information (face info, name, birthday) registered to Face ID. However, names recorded in previously shot images will not be erased.

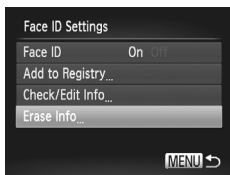

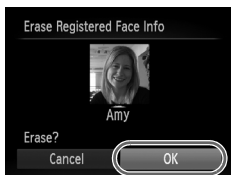

1 Access the [Erase Info] screen.

- Follow step 1 on p. 61 and choose [Erase Info].



2 Choose the name of the person whose info you want to erase.

- Press the ▲▼◀▶ buttons to choose the name of a person to erase, and then press the  button.
- After [Erase?] is displayed, press the ◀▶ buttons to choose [OK], and then press the  button.



- If you erase a registered person's info, you will not be able to display their name (p. 128), overwrite their info (p. 67), or search images for them (p. 130).



- You can also erase a person's name only from images (p. 134).

Changing the Aspect Ratio

Change the image aspect ratio (ratio of width to height) as follows.

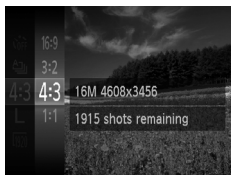

Configure the setting.

- Press the **FUNC/SET** button, choose **4:3** in the menu, and choose the desired option (p. 41).
- ▶ Once the setting is complete, the screen aspect ratio will be updated.
- To restore the original setting, repeat this process but choose **4:3**.

| | |
|-------------|---|
| 16:9 | Same aspect ratio as HDTVs, used for display on widescreen HDTVs or similar display devices. |
| 3:2 | Same aspect ratio as 35 mm film, used for printing images at 5 x 7-inch or postcard sizes. |
| 4:3 | Native aspect ratio of the camera screen, used for printing images at 3.5 x 5-inch or A-series sizes. |
| 1:1 | Square aspect ratio. |



- At aspect ratios other than **4:3**, digital zoom (p. 55) is not available ([Digital Zoom] is set to [Off]).
- Zooming is not possible during movie recording at aspect ratios other than **4:3**.

Changing Image Resolution (Size)

Choose from 4 levels of image resolution, as follows. For guidelines on how many shots at each resolution setting can fit on a memory card, see “Specifications” (p. 32).

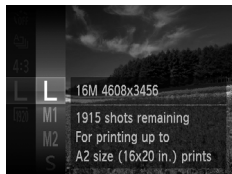

Configure the setting.

- Press the button, choose **L** in the menu, and choose the desired option (p. 41).
- ▶ The option you configured is now displayed.
- To restore the original setting, repeat this process but choose **L**.

Guidelines for Choosing Resolution Based on Paper Size (for 4:3 Images)

| | |
|--|-----------|
| A2 (16.5 x 23.4 in.) | L |
| A3 – A5 (11.7 x 16.5 – 5.8 x 8.3 in.) | M1 |
| 5 x 7 in. Postcard 3.5 x 5 in. | M2 |

- **S** : For e-mailing images.

Red-Eye Correction

Red-eye that occurs in the flash photography can be automatically corrected as follows.

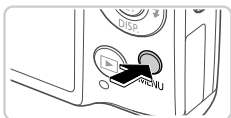

1 Access the [Flash Settings] screen.

- Press the **MENU** button, choose [Flash Settings] on the tab, and then press the button (p. 42).

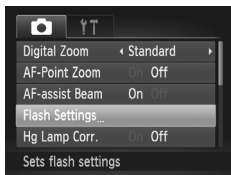

2 Configure the setting.

- Choose [Red-Eye Corr.], and then choose [On] (p. 42).
- ▶ Once the setting is complete, is displayed.
- To restore the original setting, repeat this process but choose [Off].

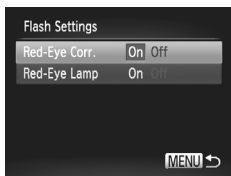

- ! Red-eye correction may be applied to image areas other than eyes (if the camera misinterprets red eye makeup as red pupils, for example).





- You can also correct existing images (p. 156).
- You can also access the screen in step 2 by pressing the button and then the **MENU** button.

Correcting Greenish Image Areas from Mercury Lamps

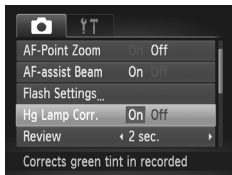
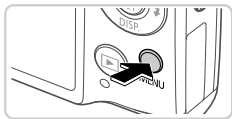
In shots of evening scenes with subjects illuminated by mercury lamps, the subjects or background may appear to have a greenish tinge. This greenish tinge can be corrected automatically when shooting, using Multi-area White Balance.



Configure the setting.

- Press the **MENU** button, choose [Hg Lamp Corr.] on the  tab, and then choose [On] (p. 42).
- ▶ Once the setting is complete,  is displayed.
- To restore the original setting, repeat this process but choose [Off].



- After you are finished shooting under mercury lamps, you should set [Hg Lamp Corr.] back to [Off]. Otherwise, green hues not caused by mercury lamps may be corrected by mistake.





- Try taking some test shots first, to make sure you obtain the desired results.

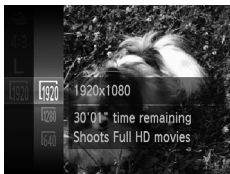

Changing Movie Image Quality

3 image quality settings are available. For guidelines on the maximum movie length at each level of image quality that will fit on a memory card, see “Specifications” (p. 32).





Configure the setting.

- Press the  button, choose  in the menu, and choose the desired option (p. 41).
- ▶ The option you configured is now displayed.
- To restore the original setting, repeat this process but choose .

| Image Quality | Resolution | Frame Rate | Details |
|---|-------------|------------|-------------------------------------|
|  | 1920 x 1080 | 24 fps | For shooting in Full HD |
|  | 1280 x 720 | 30 fps | For shooting in HD |
|  | 640 x 480 | 30 fps | For shooting in standard definition |



- In  and  modes, black bars displayed on the top and bottom edges of the screen indicate image areas not recorded.

Displaying Grid Lines

Grid lines can be displayed on the screen for vertical and horizontal reference while shooting.

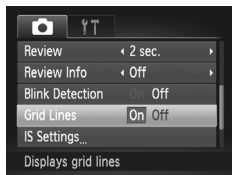
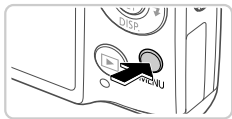

Configure the setting.

- Press the **MENU** button, choose [Grid Lines] on the  tab, and then choose [On] (p. 42).
- ▶ Once the setting is complete, grid lines are displayed on the screen.
- To restore the original setting, repeat this process but choose [Off].



- Grid lines are not recorded in your shots.

Magnifying the Area in Focus

You can check the focus by pressing the shutter button halfway to enlarge the image area in the AF frame.

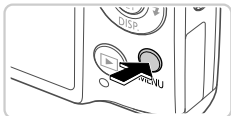

1 Configure the setting.

- Press the **MENU** button, choose [AF-Point Zoom] on the  tab, and then choose [On] (p. 42).

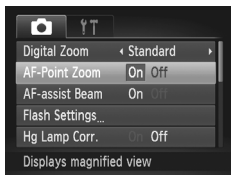

2 Check the focus.

- Press the shutter button halfway. The face detected as the main subject is now magnified.
- To restore the original setting, choose [Off] in step 1.



- The display will not magnify if a face was not detected, or if the person is too close to the camera and their face is too large for the screen.





- The magnified display will not appear when using the digital zoom (p. 55), digital tele-converter (p. 115), Tracking AF (p. 117), Servo AF (p. 119) or when using a TV as a display (p. 175).

Checking for Closed Eyes

 is displayed when the camera detects that people may have closed their eyes.



1 Choose .

- Press the  button, choose  in the menu, and choose .

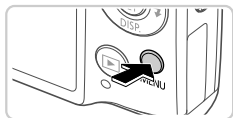
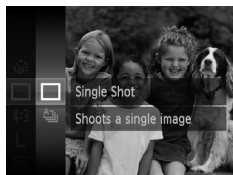

2 Configure the setting.

- Press the **MENU** button, choose [Blink Detection] on the  tab, and then choose [On] (p. 42).

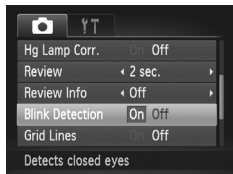

3 Shoot.

- ▶ A frame, accompanied by , is displayed when the camera detects a person whose eyes are closed.
- To restore the original setting, choose [Off] in step 2.



- When you have specified multiple shots in  mode, this function is only available for the final shot.

Customizing Camera Operation

Customize shooting functions on the  tab of the menu as follows. For instructions on menu functions, see “MENU Menu” (p. 42).

Deactivating the AF Assist Beam

You can deactivate the lamp that normally lights up to help you focus when you press the shutter button halfway in low-light conditions.

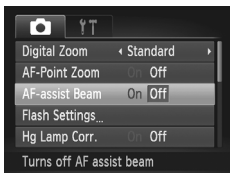

Configure the setting.



- Press the **MENU** button, choose [AF-assist Beam] on the  tab, and then choose [Off] (p. 42).
- To restore the original setting, repeat this process but choose [On].

Deactivating the Red-Eye Reduction Lamp

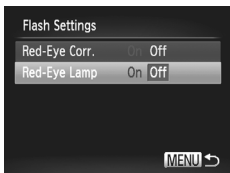
You can deactivate the red-eye reduction lamp that lights up to reduce red-eye when the flash is used in low-light shots.



1 Access the [Flash Settings] screen.

- Press the **MENU** button, choose [Flash Settings] on the  tab, and then press the  button (p. 42).

2 Configure the setting.

- Choose [Red-Eye Lamp], and then choose [Off] (p. 42).
- To restore the original setting, repeat this process but choose [On].

Changing the Image Display Period After Shots

Change how long images are displayed after shots as follows.

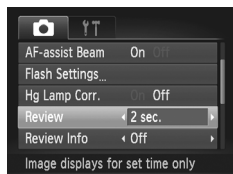

Configure the setting.

- Press the **MENU** button, choose [Review] on the tab, and then choose the desired option (p. 42).
- To restore the original setting, repeat this process but choose [2 sec.].

| | |
|-------------|---|
| 2 – 10 sec. | Displays images for the specified time. |
| Hold | Displays images until you press the shutter button halfway. |
| Off | No image display after shots. |

Changing the Image Display Style After Shots

Change the way images are displayed after shots as follows.

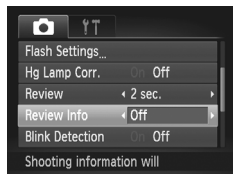

Configure the setting.

- Press the **MENU** button, choose [Review Info] on the tab, and then choose the desired option (p. 42).
- To restore the original setting, repeat this process but choose [Off].

| | |
|-------------|---|
| Off | Displays only the image. |
| Detailed | Displays shooting details (p. 206). |
| Focus Check | Shows the area in the AF frame magnified, enabling you to check the focus. Follow the steps in "Checking the Focus" (p. 129). |

3

Other Shooting Modes

Shoot more effectively in various scenes, and take shots enhanced with unique image effects or captured using special functions

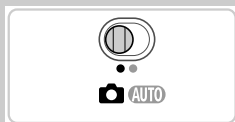

Specific Scenes

Choose a mode matching the shooting scene, and the camera will automatically configure the settings for optimal shots.



1 Enter mode.

- Set the mode switch to .

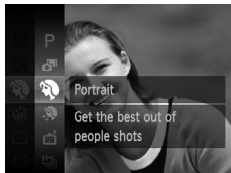

2 Choose a shooting mode.

- Press the  button, choose **P** in the menu, and then choose a shooting mode (p. 41).

3 Shoot.



Shoot portraits (Portrait)

- Take shots of people with a softening effect.



Shoot evening scenes without using a tripod (Handheld NightScene)

- Beautiful shots of evening scenes, created by combining consecutive shots to reduce camera shake and image noise.
- When using a tripod, shoot in **AUTO** mode (p. 46).

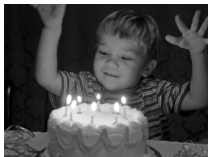

Still Images

Shoot under low light (Low Light)

- Shoot with minimal camera shake and subject blur even in low-light conditions.



Still Images

Movies

Shoot under water (Underwater)

- Natural-colored shots of sea life and underwater scenery, when you use an optional waterproof case (p. 174).
- This mode can correct white balance and match the effect of using a commercially available color-compensating filter (p. 84).









Still Images

Movies

Shoot with snowy backgrounds (Snow)

- Bright, natural-colored shots of people against snowy backgrounds.

-
- ! Because the camera will shoot continuously in  mode, hold it steady while shooting.
 - In  mode, shooting conditions that cause excessive camera shake or similar issues may prevent the camera from combining images, and you may not be able to obtain the expected results.

-
-  In  and  modes, shots may look grainy because the ISO speed (p. 108) is increased to suit the shooting conditions.
 -  mode resolution is **M** (2304 x 1728) and cannot be changed.

Correcting White Balance



White balance can be manually corrected in  mode (p. 83). This adjustment can match the effect of using a commercially available color-compensating filter.

1 Choose .

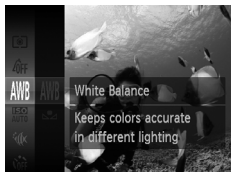
- Follow steps 1 – 2 on p. 82 and choose .



2 Choose white balance.

- Press the  button, choose **AWB** in the menu, and press the  button again.

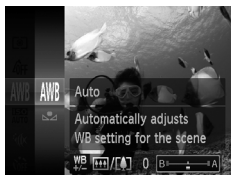

3 Adjust the setting.

- Move the zoom lever to adjust the correction level for B and A, and then press the  button.



- The camera will retain white balance correction levels even if you switch to another white balance option in step 2, but correction levels will be reset if you record custom white balance data.







- B represents blue and A, amber.
- White balance can also be manually corrected by recording custom white balance data (p. 111) before following the preceding steps.

Making Skin Look Smoother (Smooth Skin)

You can apply a smoothening effect when shooting images of people. The effect level and color ([Lighter Skin Tone], [Darker Skin Tone]) can be chosen as follows.



- 1 **Choose** .
 - Follow steps 1 – 2 on p. 82 and choose .
- 2 **Access the setting screen.**
 - Press the ▼ button.
- 3 **Configure the setting.**
 - Press the ▲▼ buttons to choose an item. Choose the effect level by pressing the ◀▶ buttons, and then press the  button.
 - ▶ A preview is shown of how your shot will look with the effect applied.
- 4 **Shoot.**

-  Areas other than people's skin may be modified.
- Try taking some test shots first to make sure you obtain the desired results.



- The effect will be stronger for the face of the person detected as the main subject.

Applying Special Effects







Add a variety of effects to images when shooting.

1 Choose a shooting mode.

- Follow steps 1 – 2 on p. 82 to choose a shooting mode.

2 Shoot.



- In , , , , , and  modes, try taking some test shots first, to make sure you obtain the desired results.



Still Images

Movies

Shoot in vivid colors (Super Vivid)

- Shots in rich, vivid colors.



Still Images

Movies

Posterized shots (Poster Effect)

- Shots that resemble an old poster or illustration.

Shooting with a Fish-Eye Lens Effect (Fish-eye Effect)

Shoot with the distorting effect of a fish-eye lens.



1 Choose .

- Follow steps 1 – 2 on p. 82 and choose .

2 Choose an effect level.

- Press the ▼ button, press the ◀▶ buttons to choose an effect level, and then press the  button.
- ▶ A preview is shown of how your shot will look with the effect applied.

3 Shoot.

Shots Resembling Miniature Models (Miniature Effect)

Creates the effect of a miniature model, by blurring image areas above and below your selected area.

You can also make movies that look like scenes in miniature models by choosing the playback speed before the movie is recorded. People and objects in the scene will move quickly during playback. Note that sound is not recorded.

1 Choose .

- Follow steps 1 – 2 on p. 82 and choose .
- ▶ A white frame is displayed, indicating the image area that will not be blurred.

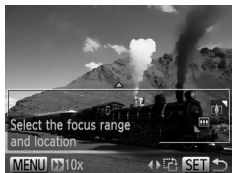

2 Choose the area to keep in focus.

- Press the ▼ button.
- Move the zoom lever to resize the frame, and press the ▲▼ buttons to move it.



3 For movies, choose the movie playback speed.

- Press the MENU button, and then press the ◀▶ buttons to choose the speed.

4 Return to the shooting screen and shoot.

- Press the MENU button to return to the shooting screen, and then shoot.

Playback Speed and Estimated Playback Time (for One-Minute Clips)

| Speed | Playback Time |
|-------|-----------------|
| 5x | Approx. 12 sec. |
| 10x | Approx. 6 sec. |
| 20x | Approx. 3 sec. |

- The zoom is not available when shooting movies. Be sure to set the zoom before shooting.



- To switch the orientation of the frame to vertical, press the ◀▶ buttons in step 2. To move the frame, press the ◀▶ buttons again. To return the frame to horizontal orientation, press the ▲▼ buttons.
- Holding the camera vertically will change the orientation of the frame.
- Movie image quality is 160 at an aspect ratio of 4:3 and 170 at an aspect ratio of 16:9 (p. 71). These quality settings cannot be changed.

Still Images

Shooting with a Toy Camera Effect (Toy Camera Effect)

This effect makes images resemble shots from a toy camera by vignetting (darker, blurred image corners) and changing the overall color.

1 Choose .

- Follow steps 1 – 2 on p. 82 and choose .

2 Choose a color tone.

- Press the ▼ button, press the ◀▶ buttons to choose a color tone, and then press the  button.
- ▶ A preview is shown of how your shot will look with the effect applied.



3 Shoot.

| | |
|----------|---|
| Standard | Shots resemble toy camera images. |
| Warm | Images have a warmer tone than with [Standard]. |
| Cool | Images have a cooler tone than with [Standard]. |

Shooting With a Soft Focus Effect

This function allows you to shoot images as if a soft focus filter is attached to the camera. You can adjust the effect level as desired.

1 Choose .

- Follow steps 1 – 2 on p. 82 and choose .

2 Choose an effect level.

- Press the ▼ button, press the ◀▶ buttons to choose an effect level, and then press the  button.
- ▶ A preview is shown of how your shot will look with the effect applied.



3 Shoot.

Shooting in Monochrome





Shoot images in black and white, sepia, or blue and white.



1 Choose .

- Follow steps 1 – 2 on p. 82 and choose .

2 Choose a color tone.

- Press the  button, press the   buttons to choose a color tone, and then press the  button.
- ▶ A preview is shown of how your shot will look with the effect applied.

3 Shoot.

| | |
|-------|------------------------|
| B/W | Black and white shots. |
| Sepia | Sepia tone shots. |
| Blue | Blue and white shots. |

Shooting with Color Accent

Choose a single image color to keep and change other colors to black and white.

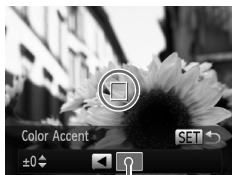
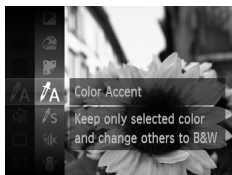

Recorded Color

1 Choose .

- Follow steps 1 – 2 on p. 82 and choose .



2 Access the setting screen.

- Press the  button.
- ▶ The original image and the Color Accent image are displayed one after another.
- ▶ By default, green is the color that will be kept.

3 Specify the color.

- Position the center frame over the color to keep, and then press the  button.
- ▶ The specified color is recorded.

4 Specify the range of colors to keep.

- Press the   buttons to adjust the range.
- To keep only your specified color, choose a large negative value. To keep colors similar to your specified color as well, choose a large positive value.
- Press the  button to return to the shooting screen.



- Using the flash in this mode may cause unexpected results.
- In some shooting scenes, images may look grainy and colors may not look as expected.

Shooting with Color Swap

You can replace one image color with another before shooting. Note that only one color can be replaced.

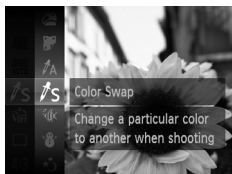

1 Choose .

- Follow steps 1 – 2 on p. 82 and choose .



2 Access the setting screen.

- Press the  button.
- ▶ The original image and the Color Swap image are displayed one after another.
- ▶ By default, green will be replaced with gray.

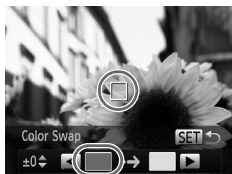

3 Specify the color to replace.

- Position the center frame over the color to replace, and then press the  button.
- ▶ The specified color is recorded.



4 Specify the new color.

- Position the center frame over the new color, and then press the ► button.
- ▶ The specified color is recorded.

5 Specify the range of colors to replace.

- Press the ▲▼ buttons to adjust the range.
- To replace only your specified color, choose a large negative value. To replace colors similar to your specified color as well, choose a large positive value.
- Press the  button to return to the shooting screen.



- Using the flash in this mode may cause unexpected results.
- In some shooting scenes, images may look grainy and colors may not look as expected.

Auto Clip Recording (Movie Digest)

You can make a short movie of a day just by shooting still images. Before each shot, the camera will automatically record a movie clip of the scene. Each clip recorded that day is combined into a single file.

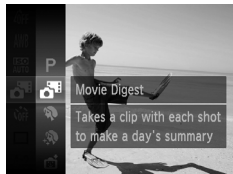

1 Choose .

- Follow steps 1 – 2 on p. 82 and choose .



2 Shoot.

- To shoot a still image, press the shutter button all the way down.
- ▶ Before shooting, the camera will automatically record a clip about 2 – 4 seconds long.



- Clips may not be recorded if you shoot a still image immediately after turning the camera on, choosing  mode, or operating the camera in other ways.
- Battery life is shorter in this mode than in **AUTO** mode, because clips are recorded for each shot.
- Any sounds from camera operations during movie recording will be included in the movie.



- Movies created in  mode are saved as iFrame movies (p. 104).
- Clips are saved as separate movie files in the following cases even if they were recorded on the same day in  mode.
 - If the movie file size reaches about 4 GB or the total recording time reaches approx. 30 minutes
 - If a movie is protected (p. 139)
 - If a movie has been edited (p. 157)
 - If a new folder is created (p. 166)
 - When the daylight saving time (p. 18) or time zone settings have been changed (p. 168)
- Some camera sounds will be muted. Sounds are not played when you press the shutter button halfway, use camera controls, or trigger the self-timer (p. 161).
- Movies created in  mode can be viewed by date (p. 132).



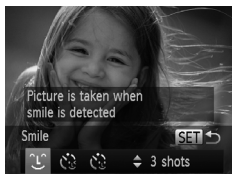

Auto Shooting After Face Detection (Smart Shutter)

Auto Shooting After Smile Detection

The camera shoots automatically after detecting a smile, even without you pressing the shutter button.





1 Choose .

- Follow steps 1 – 2 on p. 82 and choose , and then press the  button.
- Press the  buttons to choose , and then press the  button.
- ▶ The camera now enters shooting standby mode, and [Smile Detection on] is displayed.





2 Aim the camera at a person.

- Each time the camera detects a smile, it will shoot after the lamp lights up.
- To pause smile detection, press the  button. Press the  button again to resume detection.



- Switch to another mode when you finish shooting, or the camera will continue shooting each time a smile is detected.







- You can also shoot as usual by pressing the shutter button.
- The camera can detect smiles more easily when subjects face the camera and open their mouth wide enough so that teeth are visible.
- To change the number of shots, press the  buttons after choosing  in step 1. [Blink Detection] (p. 78) is only available for the final shot.

Using the Wink Self-Timer

Aim the camera at a person and press the shutter button all the way down. The camera will shoot about two seconds after a wink is detected.



1 Choose .

- Follow steps 1 – 2 on p. 82 and choose , and then press the  button.
- Press the  buttons to choose , and then press the  button.

2 Compose the shot and press the shutter button halfway.

- Make sure a green frame is displayed around the face of the person who will wink.

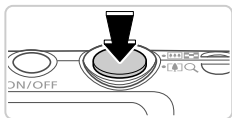

3 Press the shutter button all the way down.



- ▶ The camera now enters shooting standby mode, and [Wink to take picture] is displayed.
- ▶ The lamp blinks and the self-timer sound is played.



4 Face the camera and wink.

- ▶ The camera will shoot about two seconds after detecting a wink by the person whose face is inside the frame.
- To cancel shooting after you have triggered the self-timer, press the **MENU** button.







- If the wink is not detected, wink again slowly and deliberately.
- Winking may not be detected if eyes are obscured by hair, a hat, or glasses.
- Closing and opening both eyes at once will also be detected as a wink.
- If winking is not detected, the camera will shoot about 15 seconds later.
- To change the number of shots, press the  buttons after choosing  in step 1. [Blink Detection] (p. 78) is only available for the final shot.
- If no one is in the shooting area when the shutter button is pressed all the way down, the camera will shoot after a person enters the shooting area and winks.

Using the Face Self-Timer

The camera will shoot about two seconds after detecting that the face of another person (such as the photographer) has entered the shooting area (p. 116). This is useful when including yourself in group photos or similar shots.



1 Choose .

- Follow steps 1 – 2 on p. 82 and choose , and then press the  button.
- Press the  buttons to choose , and then press the .

2 Compose the shot and press the shutter button halfway.

- Make sure a green frame is displayed around the face you focus on and white frames around other faces.

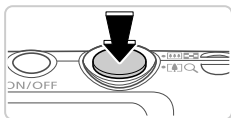

3 Press the shutter button all the way down.

- ▶ The camera now enters shooting standby mode, and [Look straight at camera to start count down] is displayed.
- ▶ The lamp blinks and the self-timer sound is played.



4 Join the subjects in the shooting area and look at the camera.

- ▶ After the camera detects a new face, the lamp blinking and self-timer sound will speed up. (When the flash fires, the lamp will remain lit.) About two seconds later, the camera will shoot.
- To cancel shooting after you have triggered the self-timer, press the **MENU** button.





- Even if your face is not detected after you join the others in the shooting area, the camera will shoot about 15 seconds later.
- To change the number of shots, press the ▲▼ buttons after choosing  in step 1. [Blink Detection] (p. 78) is only available for the final shot.

Still Images

Shooting Long Exposures (Long Shutter)

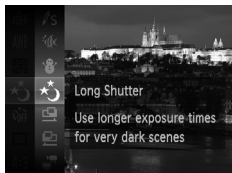
Specify a shutter speed of 1 – 15 seconds to shoot long exposures. In this case, mount the camera on a tripod or take other measures to prevent camera shake.

**1 Choose .**

- Follow steps 1 – 2 on p. 82 and choose .

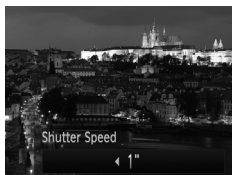
**2 Choose the shutter speed.**

- Press the ▲ button, press the ◀▶ buttons to choose the shutter speed, and then press the  button.

3 Check the exposure.

- Press the shutter button halfway to view the exposure for your selected shutter speed.

4 Shoot.

- On-screen image brightness in step 3, when you pressed the shutter button halfway, may not match the brightness of your shots.
- With shutter speeds of 1.3 seconds or slower, there will be a delay before you can shoot again, as the camera processes images to reduce noise.
- Set [IS Mode] to [Off] when using a tripod or other means to hold the camera still (p. 123).



- If the flash fires, your shot may be overexposed. In this case, set the flash to  and shoot again.

High-Speed Continuous Shooting (High-speed Burst)

You can shoot a series of shots in rapid succession by holding the shutter button all the way down. For details on the continuous shooting speed, see “Specifications” (p. 32).



1 Choose .

- Follow steps 1 – 2 on p. 82 and choose .

2 Shoot.

- ▶ Hold the shutter button all the way down to shoot continuously.



- The resolution is **M** (2304 x 1728) and cannot be changed.
- Focus, image brightness, and color are determined by the first shot.
- Shooting may stop momentarily or continuous shooting may slow down depending on shooting conditions, camera settings, and the zoom position.
- As more shots are taken, shooting may slow down.
- When using Face ID (p. 61), the location in the image where the name is recorded will be determined in the first shot, and will be recorded in the same place for further shots.

Images Displayed During Playback

Each set of images shot continuously is managed as a single group, and only the first image in that group will be displayed. To indicate that the image is part of a group, **SET**  is displayed in the upper left of the screen.



- If you erase a grouped image (p. 143), all images in the group are also erased. Be careful when erasing images.





- Grouped images can be played back individually (p. 132) and ungrouped (p. 133).
- Protecting (p. 139) a grouped image will protect all images in the group.
- Grouped images can be viewed individually when played back using Image Search (p. 130) or Smart Shuffle (p. 137). In this case, images are temporarily ungrouped.
- Grouped images cannot have their Face ID info edited (p. 133), be tagged as favorites (p. 148), edited (pp. 146 – 156), categorized (p. 149), assigned as a start-up image (p. 163), printed (p. 181), be set for printing individually (p. 190), or added to a Photobook (p. 192). To do these things, either view grouped images individually (p. 132) or cancel grouping (p. 133) first.

Shooting Stitch Assist Images

Shoot a large subject by taking multiple shots at various positions, and then use the included software to combine them into a panorama.

1 Choose or .

- Follow steps 1 – 2 on p. 82 and choose  or .

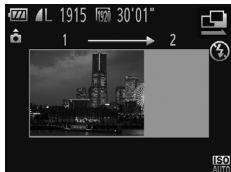

2 Take the first shot.

- ▶ The first shot will determine the exposure and white balance.



3 Take additional shots.

- Compose the second shot so that it partially overlaps the image area of first shot.
- Minor misalignment of overlapping portions will be corrected automatically when the images are combined.
- Take up to 26 shots, the same way you took the second shot.

4 Finish shooting.

- Press the  button.



5 Use the software to combine the images.

- For instructions on merging images, refer to the *ImageBrowser EX User Guide*.



- This function is not available when using a TV as a display while shooting (p. 176).

Shooting Various Movies

Shooting Super Slow Motion Movies



You can shoot fast-moving subjects for playback later in slow motion. Note that sound is not recorded.

1 Choose .

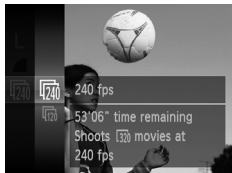
- Follow steps 1 – 2 on p. 82 and choose .







2 Choose a frame rate.

- Press the  button, choose  in the menu, and choose the desired frame rate (p. 41).
- The option you configured is now displayed.



3 Shoot.

- Press the movie button.
- A bar showing the elapsed time is displayed. Maximum clip length is approx. 30 sec.
- To stop movie recording, press the movie button again.

| Frame Rate | Image Quality | Playback Time (For a 30-sec. Clip) |
|--|--|---------------------------------------|
|  240 fps |  (320x240) | Approx. 4 min. |
|  120 fps |  (640x480) | Approx. 2 min. |



- Zooming is not available during recording, even if you move the zoom lever.
- Focus, exposure, and color are determined when you press the movie button.



- The movie will be played back in slow motion when you follow steps 1 – 3 on p. 126.
- You can change the playback speed of movies shot in  mode by using the included software. For details, refer to the *ImageBrowser EX User Guide*.

Shooting iFrame Movies

Shoot movies that can be edited with iFrame-compatible software or devices. You can quickly edit, save, and manage iFrame movies using the included software.

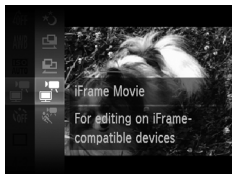

1 Choose .

- Follow steps 1 – 2 on p. 82 and choose .
- ▶ Black bars displayed on the top and bottom edges of the screen indicate image areas not recorded.

2 Shoot.

- Press the movie button.
- To stop movie recording, press the movie button again.





- The resolution is  (p. 75) and cannot be changed.
- iFrame is a video format developed by Apple.

4

P mode

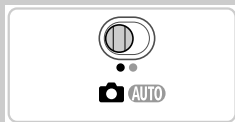
More discerning shots, in your preferred shooting style



- Instructions in this chapter apply to the camera in **P** mode, with the mode switch set to .
- **P**: Program AE; AE: Auto Exposure
- Before using a function introduced in this chapter in modes other than **P**, make sure the function is available in that mode (pp. 208 – 213).

Shooting in Program AE Mode (P Mode)

You can customize many function settings to suit your preferred shooting style.



1 Enter **P** mode.

- Follow steps 1 – 2 on p. 82 and choose **P**.

2 Customize the settings as desired (pp. 107 – 123), and then shoot.



- If adequate exposure cannot be obtained when you press the shutter button halfway, shutter speeds and aperture values are displayed in orange. To obtain adequate exposure, try adjusting the following settings.
 - Activate the flash (p. 121)
 - Choose a higher ISO speed (p. 108)
- Movies can be recorded in **P** mode as well, by pressing the movie button. However, some **FUNC.** and **MENU** settings may be automatically adjusted for movie recording.
- For details on the shooting range in **P** mode, see “Specifications” (p. 32).

Image Brightness (Exposure Compensation)

Still Images

Movies

Adjusting Image Brightness (Exposure Compensation)

The standard exposure set by the camera can be adjusted in 1/3-stop increments, in a range of -2 to +2.



Exposure Compensation Bar

- Press the **▲** button. As you watch the screen, press the **◀▶** buttons to adjust the brightness.
- When shooting movies, shoot with the exposure compensation bar displayed. When shooting still images, press the **FUNC SET** button to display the set exposure compensation amount, and then shoot.



- You can also shoot still images with exposure compensation bar displayed.
- While recording a movie, **AEL** is displayed, and the exposure is locked.

Still Images

Movies

Locking Image Brightness/Exposure (AE Lock)

Before shooting, you can lock the exposure, or you can specify focus and exposure separately.

1 Set the flash to (p. 58).



2 Lock the exposure.

- Aim the camera at the subject to shoot with the exposure locked. With the shutter button pressed halfway, press the **▲** button.
- ▶ **AEL** is displayed, and the exposure is locked.
- To unlock AE, release the shutter button and press the **▲** button again. In this case, **AEL** is no longer displayed.

3 Compose the shot and shoot.



- **AE**: Auto Exposure

Changing the Metering Method

Adjust the metering method (how brightness is measured) to suit shooting conditions as follows.

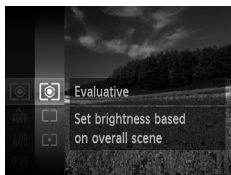

- Press the **FUNC SET** button, choose **[]** in the menu, and choose the desired option (p. 41).
- ▶ The option you configured is now displayed.

| | |
|----------------------|---|
| Evaluative | For typical shooting conditions, including backlit shots. Automatically adjusts exposure to match the shooting conditions. |
| Center Weighted Avg. | Determines the average brightness of light across the entire image area, calculated by treating brightness in the central area as more important. |
| Spot | Metering restricted to within the [] (Spot AE Point frame), displayed in the center of the screen. |

Changing the ISO Speed

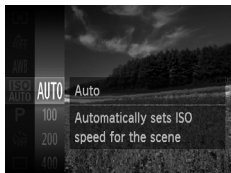

- Press the **FUNC SET** button, choose **ISO AUTO** in the menu, and choose the desired option (p. 41).
- ▶ The option you configured is now displayed.

| | | |
|---------------------------------------|---|--|
| ISO AUTO | Automatically adjusts the ISO speed to suit the shooting mode and conditions. | |
| ISO 100 ISO 200 | Low | For shooting outdoors in fair weather. |
| ISO 400 ISO 800 | ↑ ↓ | For shooting in cloudy conditions, or at twilight. |
| ISO 1600 ISO 3200 | High | For shooting night scenes, or in dark rooms. |





- To view the automatically set ISO speed when the camera is set to **ISO AUTO**, press the shutter button halfway.
- Although choosing a lower ISO speed may reduce image graininess, there may be a greater risk of subject blurriness in some shooting conditions.
- Choosing a higher ISO speed will increase shutter speed, which may reduce subject blurriness and increase the flash range. However, shots may look grainy.

Still Images

Correcting Image Brightness (i-Contrast)

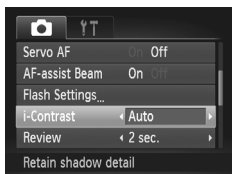
Before shooting, excessively bright or dark image areas (such as faces or backgrounds) can be detected and automatically adjusted to the optimal brightness. Insufficient overall image contrast can also be automatically corrected before shooting to make subjects stand out better.



- Press the **MENU** button, choose [i-Contrast] on the  tab, and then choose [Auto] (p. 42).
- ▶ Once the setting is complete,  is displayed.



- Under some shooting conditions, correction may be inaccurate or may cause images to appear grainy.









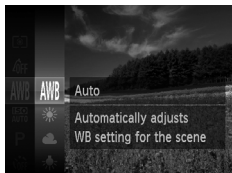

- You can also correct existing images (p. 155).

Adjusting White Balance

By adjusting white balance (WB), you can make image colors look more natural for the scene you are shooting.





- Press the  button, choose **AWB** in the menu, and choose the desired option (p. 41).
- ▶ The option you configured is now displayed.

| | | |
|--|---------------|--|
|  AWB | Auto | Automatically sets the optimal white balance for the shooting conditions. |
|  | Day Light | For shooting outdoors in fair weather. |
|  | Cloudy | For shooting in cloudy conditions, in the shade, or at twilight. |
|  | Tungsten | For shooting under ordinary incandescent (tungsten) lighting and similarly colored fluorescent lighting. |
|  | Fluorescent | For shooting under warm-white, cool-white, and similarly colored fluorescent lighting. |
|  | Fluorescent H | For shooting under daylight fluorescent and similarly colored fluorescent lighting. |
|  | Custom | For manually setting a custom white balance (p. 111). |

Custom White Balance

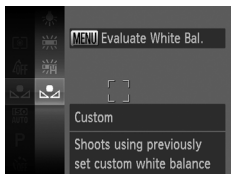
For image colors that look natural under the light in your shot, adjust white balance to suit the light source where you are shooting. Set the white balance under the same light source that will illuminate your shot.



- Follow the steps in “Adjusting White Balance” (p. 110) to choose .
- Aim the camera at a plain white subject, so that the entire screen is white. Press the **MENU** button.
- ▶ The tint of the screen changes once the white balance data has been recorded.



- Colors may look unnatural if you change camera settings after recording white balance data.

Changing Image Color Tones (My Colors)

Change image color tones as desired, such as converting images to sepia or black and white.

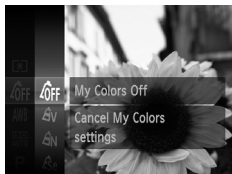

- Press the **FUNC/SET** button, choose **OFF** in the menu, and choose the desired option (p. 41).
- ▶ The option you configured is now displayed.

| | |
|----------------------------|--|
| OFF My Colors Off | — |
| V Vivid | Emphasizes contrast and color saturation, making images sharper. |
| N Neutral | Tones down contrast and color saturation for subdued images. |
| Se Sepia | Creates sepia tone images. |
| BW B/W | Creates black and white images. |
| P Positive Film | Combines the effects of Vivid Blue, Vivid Green, and Vivid Red to produce intense yet natural-looking colors resembling images on positive film. |
| L Lighter Skin Tone | Lightens skin tones. |
| D Darker Skin Tone | Darkens skin tones. |
| B Vivid Blue | Emphasizes blues in images. Makes the sky, ocean, and other blue subjects more vivid. |
| G Vivid Green | Emphasizes greens in images. Makes mountains, foliage, and other green subjects more vivid. |
| R Vivid Red | Emphasizes reds in images. Makes red subjects more vivid. |
| C Custom Color | Adjust contrast, sharpness, color saturation, and other qualities as desired (p. 113). |



- White balance (p. 110) cannot be set in **Se** or **BW** modes.
- With **L** and **D** modes, colors other than people's skin tone may be modified. These settings may not produce the expected results with some skin tones.

Custom Color



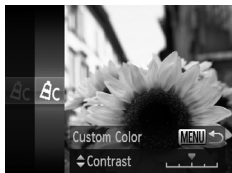

Choose the desired level of image contrast, sharpness, color saturation, red, green, blue, and skin tones in a range of 1 – 5.



1 Access the setting screen.

- Follow the steps in “Changing Image Color Tones (My Colors)” (p. 112) to choose , and then press the **MENU** button.

2 Configure the setting.

- Press the   buttons to choose an option, and then press the   buttons to specify the value.
- For stronger/more intense effects (or darker skin tones), adjust the value to the right, and for weaker/lighter effects (or lighter skin tones), adjust the value to the left.
- Press the **MENU** button to complete the setting.



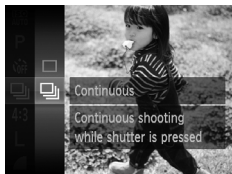

Still Images

Continuous Shooting

Hold the shutter button all the way down to shoot continuously.
For details on the continuous shooting speed, see “Specifications” (p. 32).



1 Configure the setting.

- Press the  button, choose  in the menu, and then choose  (p. 41).
- ▶ Once the setting is complete,  is displayed.

2 Shoot.

- ▶ Hold the shutter button all the way down to shoot continuously.

- ❗ Cannot be used with the self-timer (p. 56) or [Blink Detection] (p. 78).
- During continuous shooting, focus and exposure are locked at the position/level determined when you pressed the shutter button halfway.
- Shooting may stop momentarily or continuous shooting may slow down depending on shooting conditions, camera settings, and the zoom position.
- As more shots are taken, shooting may slow down.
- Shooting may slow down if the flash fires.



- If you use Face ID (p. 61) in , the name recorded in the image will be fixed to the location where it is displayed in the first shot. Even if the subject moves, the name will stay fixed in the same position for any subsequent shots.





Shooting Range and Focusing

Still Images

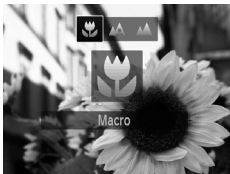
Shooting Close-ups (Macro)

To restrict the focus to subjects at close range, set the camera to . For details on the focusing range, see “Specifications” (p. 32).



- Press the  button, press the  buttons to choose , and then press the  button.
- ▶ Once the setting is complete,  is displayed.

- ❗ If the flash fires, vignetting may occur.
- In the yellow bar display area below the zoom bar,  will turn gray and the camera will not focus.



- To prevent camera shake, try mounting the camera on a tripod and shooting with the camera set to  (p. 57).

Shooting Distant Subjects (Infinity)

To restrict the focus to distant subjects, set the camera to . For details on the focusing range, see “Specifications” (p. 32).



- Press the button, press the buttons to choose , and then press the button.
- ▶ Once the setting is complete, is displayed.

Digital Tele-Converter

The focal length of the lens can be increased by approximately 1.6x or 2.0x. This can reduce camera shake because the shutter speed is faster than it would be if you zoomed (including using digital zoom) in to the same zoom factor.



- Press the **MENU** button, choose [Digital Zoom] on the tab, and then choose the desired option (p. 42).
- ▶ The view is enlarged and the zoom factor is displayed on the screen.



- The digital tele-converter cannot be used with digital zoom (p. 55) and AF-point zoom (p. 77).
- The digital tele-converter is only available when the aspect ratio is 4:3.



- The respective focal lengths when using [1.6x] and [2.0x] are 38.4 – 192 mm and 48.0 – 240 mm (35mm film equivalent).
- The shutter speed may be equivalent when you move the zoom lever all the way toward for maximum telephoto, and when you zoom in to enlarge the subject to the same size following step 2 on p. 55.

Changing the AF Frame Mode

Change the AF (auto focus) frame mode to suit the shooting conditions as follows.

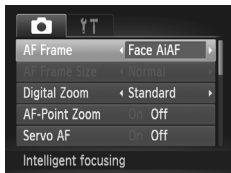

- Press the **MENU** button, choose [AF Frame] on the  tab, and then choose the desired option (p. 42).

Face AiAF

- Detects people's faces, and then sets the focus, exposure (evaluative metering only), and white balance (**AWB** only).
- After you aim the camera at the subject, a white frame is displayed around the person's face determined by the camera to be the main subject, and up to two gray frames are displayed around other detected faces.
- When the camera detects movement, frames will follow moving subjects, within a certain range.
- After you press the shutter button halfway, up to nine green frames are displayed around faces in focus.

- ❗ If faces are not detected, or when only gray frames are displayed (without a white frame), up to nine green frames are displayed in the areas in focus when you press the shutter button halfway.
- If faces are not detected when Servo AF (p. 119) is set to [On], the AF frame is displayed in the center of the screen when you press the shutter button halfway.
- Examples of faces that cannot be detected:
 - Subjects that are distant or extremely close
 - Subjects that are dark or light
 - Faces in profile, at an angle, or partly hidden
- The camera may misinterpret non-human subjects as faces.
- No AF frames are displayed if the camera cannot focus when you press the shutter button halfway.

Still Images

Choosing Subjects to Focus On (Tracking AF)



Shoot after choosing a subject to focus on as follows.

1 Choose [Tracking AF].



- Follow the steps in “Changing the AF Frame Mode” (p. 116) to choose [Tracking AF].
- ▶  is displayed in the center of the screen.





2 Choose a subject to focus on.



- Aim the camera so that  is on the desired subject, and then press the  button.





- ▶ When the subject is detected, the camera beeps and  is displayed. Even if the subject moves, the camera will continue to track the subject within a certain range.
- ▶ If no subject is detected,  is displayed.
- To cancel tracking, press the  button again.

3 Shoot.

- Press the shutter button halfway.  changes to a blue , which follows the subject as the camera continues to adjust the focus and exposure (Servo AF) (p. 119).
- Press the shutter button all the way down to shoot.
- ▶ Even after your shot,  is still displayed and the camera continues to track the subject.

-
- ! [Servo AF] (p. 119) is set to [On] and cannot be changed.
 - Tracking may not be possible when subjects are too small or move too rapidly, or when subject color or brightness matches that of the background too closely.
 - [AF-Point Zoom] on the  tab is not available.
 -  and  are not available.



- The camera can detect subjects even if you press the shutter button halfway without pressing the  button. After your shot,  is displayed in the center of the screen.
- If [Face ID] is set to [On], names will not display when registered people are detected, but the names will be recorded in the still images (p. 61). However, a name will display if the subject chosen to focus on is the same as a person detected with Face ID.

Still Images

Movies

Center

One AF frame is displayed in the center. Effective for reliable focusing.



- A yellow AF frame is displayed with  if the camera cannot focus when you press the shutter button halfway. Note that AF-point zooming (p. 77) is not possible.



- To reduce the AF frame size, press the **MENU** button and set [AF Frame Size] on the  tab to [Small] (p. 42).
- The AF frame size is set to [Normal] when you use the digital zoom (p. 55) or digital tele-converter (p. 115).
- If [Face ID] is set to [On], names will not display when registered people are detected, but the names will be recorded in the still images (p. 61).

Recomposing Shots While the Focus is Locked

As long as you keep the shutter button pressed halfway, the focus and exposure are locked. You can recompose shots as needed before shooting. This feature is called Focus Lock.



1 Focus.

- Aim the camera so that the subject is centered, and then press the shutter button halfway.
- Confirm that the AF frame displayed around the subject is green.



2 Recompose the shot.

- Keeping the shutter button pressed halfway, move the camera to recompose the shot.

3 Shoot.

- Press the shutter button all the way down.

Shooting with Servo AF

This mode helps avoid missing shots of subjects in motion, because the camera continues to focus on the subject and adjust the exposure as long as you press the shutter button halfway.

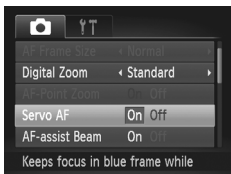

1 Configure the setting.

- Press the **MENU** button, choose [Servo AF] on the  tab, and then choose [On] (p. 42).

2 Focus.

- The focus and exposure are maintained where the blue AF frame is displayed while you are pressing the shutter button halfway.



- Focusing may not be possible in some shooting conditions.
- In low-light conditions, Servo AF may not be activated (AF frames may not turn blue) when you press the shutter button halfway. In this case, the focus and exposure are set according to the specified AF frame mode.
- If adequate exposure cannot be obtained, shutter speeds and aperture values are displayed in orange. Release the shutter button, and then press it halfway again.
- AF lock shooting is not available.
- [AF-Point Zoom] on the  tab is not available.
- Not available when using the self-timer (p. 56).

Still Images



Movies

Shooting with the AF Lock

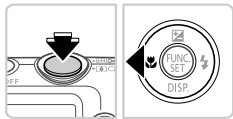
The focus can be locked. After you lock the focus, the focal position will not change even when you release your finger from the shutter button.



1 Lock the focus.

- With the shutter button pressed halfway, press the  button.
- ▶ The focus is now locked, and AFL is displayed.
- To unlock the focus, release the shutter button and press the  button again. In this case, AFL is no longer displayed.

2 Compose the shot and shoot.

Flash

Activating Flash

You can have the flash fire for each shot. For details on the flash range, see “Flash Range” (see “Specifications” (p. 32)).



- Press the **▶** button, press the **◀▶** buttons to choose **⚡**, and then press the **FUNC. SET** button.
- ▶ Once the setting is complete, **⚡** is displayed.

Shooting with Slow Synchro

With this option, the flash fires to increase the brightness of the main subject (such as people) while the camera shoots at a slow shutter speed to increase the brightness of the background that is out of the flash range.

For details on the flash range, see “Flash Range” (see “Specifications” (p. 32)).

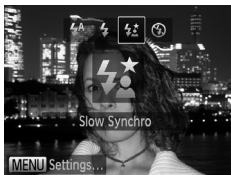

1 Configure the setting.

- Press the **▶** button, press the **◀▶** buttons to choose **⚡***, and then press the **FUNC. SET** button.
- ▶ Once the setting is complete, **⚡*** is displayed.

2 Shoot.

- Even after the flash fires, ensure that the main subject does not move until the shutter sound is finished playing.

- ⓘ Mount the camera on a tripod or take other measures to keep it still and prevent camera shake. In this case, set [IS Mode] to [Off] (p. 123).



Shooting with the FE Lock

Just as with the AE lock (p. 107), you can lock the exposure for the flash shots.

1 Set the flash to (p. 121).



2 Lock the flash exposure.



- Aim the camera at the subject to shoot with the exposure locked. With the shutter button pressed halfway, press the  button.
 - ▶ The flash fires, and when FEL is displayed, the flash output level is retained.
- To unlock FE, release the shutter button and press the  button again. In this case, FEL is no longer displayed.

3 Compose the shot and shoot.





• FE: Flash Exposure

Changing the Compression Ratio (Image Quality)

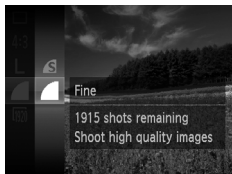
Choose from two compression ratios, as follows:  (Super Fine),  (Fine). For guidelines on how many shots at each compression ratio can fit on a memory card, see “Specifications” (p. 32).





Configure the setting.

- Press the  button, choose  in the menu, and choose the desired option (p. 41).
- ▶ The option you configured is now displayed.

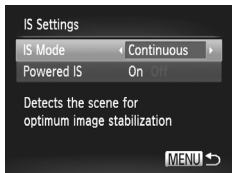
Changing the IS Mode Settings



1 Access the setting screen.

- Press the **MENU** button, choose [IS Settings] on the  tab, and then press the  button (p. 42).

2 Configure the setting.

- Choose [IS Mode], and then choose the desired option (p. 42).

| | |
|-------------|--|
| Continuous | Optimal image stabilization for the shooting conditions is automatically applied (Intelligent IS) (p. 53). |
| Shoot Only* | Image stabilization is active only at the moment of shooting. |
| Off | Deactivates image stabilization. |

* The setting is changed to [Continuous] for movie recording.



- If image stabilization cannot prevent camera shake, mount the camera on a tripod or take other measures to hold it still. In this case, set [IS Mode] to [Off].

■ Deactivating Powered IS

Powered IS reduces slow camera shake that may occur when recording telephoto movies. However, this option may not produce the expected results when used for the stronger camera shake that may occur when shooting while walking or when moving the camera to match subject movement. In this case, set Powered IS to [Off].

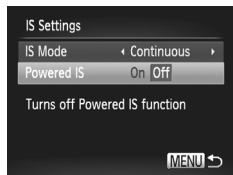

- Follow the steps in “Changing the IS Mode Settings” (p. 123) to access the [IS Settings] screen.
- Choose [Powered IS], and then choose [Off] (p. 42).



- [Powered IS] settings are not applied when [IS Mode] is set to [Off].

5

Playback Mode

Have fun reviewing your shots, and browse or edit them in many ways

- To prepare the camera for these operations, press the  button to enter Playback mode.



It may not be possible to play back or edit images that were renamed or already edited on a computer, or images from other cameras.

Viewing

After shooting images or movies, you can view them on the screen as follows.

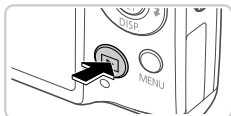

1 Enter Playback mode.

- Press the button.
- ▶ Your last shot is displayed.



2 Browse through your images.

- To view the previous image, press the ◀ button. To view the next image, press the ▶ button.



- To access Scroll Display mode, press and hold the ◀▶ buttons for at least one second. In this mode, press the ◀▶ buttons to browse through images.
- To return to single-image display, press the button.
- To browse images grouped by shooting date, press the ▲▼ buttons in Scroll Display mode.
- Movies are identified by a icon. To play movies, go to step 3.



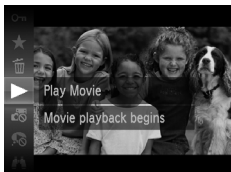

3 Play movies.

- To start playback, press the **FUNC/SET** button, press the **▲▼** buttons to choose **▶**, and then press the **FUNC/SET** button again.

4 Adjust the volume.

- Press the **▲▼** buttons to adjust the volume.

5 Pause playback.

- To pause playback, press the **FUNC/SET** button. The movie control panel is displayed. To resume playback, press the **◀▶** buttons to choose **▶**, and then press the **FUNC/SET** button.
- After the movie is finished, **SET** is displayed.



- To switch to Shooting mode from Playback mode, press the shutter button halfway.
- To deactivate Scroll Display, press the **MENU** button, choose [Scroll Display] on the **▶** tab, and then choose [Off].
- For playback from the last image viewed, press the **MENU** button, choose [Resume] on the **▶** tab, and then [Last seen].
- To change the transition shown between images, press the **MENU** button, choose [Transition] on the **▶** tab, and then press the **◀▶** buttons to choose the effect.

Still Images

Checking People Detected in Face ID

If you switch the camera to simple information display mode (p. 128), the names of up to five detected people registered in Face ID (p. 61) will be displayed.



Switch to simple information display mode and check.

- Press the **▼** button repeatedly until simple information display is activated, and then press the **◀▶** buttons to choose an image.
- Names will be displayed on detected people.



- If you do not want names to display on images shot using Face ID, press the **MENU** button, choose [Face ID Info] on the **▶** tab, and then set [Name Display] to [Off].

Switching Display Modes

Press the **▼** button to view other information on the screen, or to hide the information. For details on the information displayed, see p. 206.

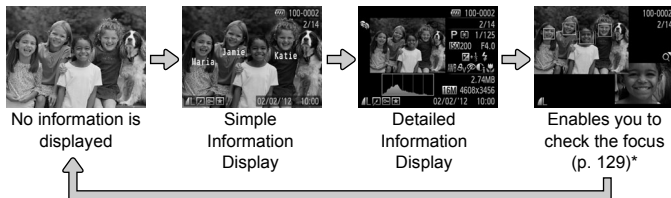

*Not shown for movies.



- Switching display modes by pressing the **▼** button is also possible immediately after you shoot, while your shot is displayed. However, simple information display is not available. To change the initial display mode, press the **MENU** button and choose [Review Info] on the **☑** tab (p. 80).

Overexposure Warning (for Image Highlights)

Washed-out highlights in the image flash on the screen in detailed information display.

Histogram

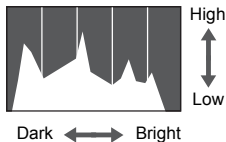

- The graph in detailed information display is a histogram showing the distribution of brightness in the image. The horizontal axis represents the degree of brightness, and the vertical axis, how much of the image is at each level of brightness. Viewing the histogram is a way to check exposure.

Checking the Focus

To check the focus of your shots, you can magnify the area of the image that was in the AF frame at the time of shooting.

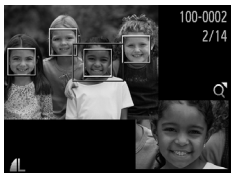

1 Access Focus Check.

- Press the ▼ button (p. 128).
- ▶ A white frame is displayed where the AF frame was when the focus was set.
- ▶ Gray frames are displayed over faces detected later, in Playback mode.
- ▶ The portion of the image in the orange frame is magnified.

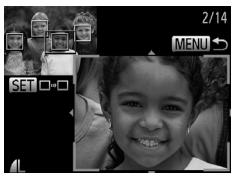

2 Switch frames.

- Move the zoom lever toward Q once.
- ▶ The screen at left is displayed.
- To switch to a different frame when there are multiple frames, press the  button.

3 Zoom in or out, or view other image areas.



- As you examine the focus, use the zoom lever to zoom in or out. Press the ▲▼◀▶ buttons to adjust the display position.
- Press the **MENU** button to restore the original display in step 1.

Navigating Through Images in an Index

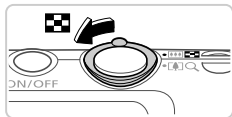
By displaying multiple images in an index, you can quickly find the images you are looking for.







1 Display images in an index.

- Move the zoom lever toward  to display images in an index. Moving the lever again will increase the number of images shown.
- To display fewer images, move the zoom lever toward . Fewer images are shown each time you move the lever.









2 Choose an image.

- Press the     buttons to choose an image.
- ▶ An orange frame is displayed around the selected image.
- Press the  button to view the selected image in single-image display.

Searching for Images

When looking for images on a memory card containing many images, you can specify search conditions to display specific images only. You can also protect (p. 139) or erase (p. 143) all images in a search result at once.

| | |
|---|--|
|  Name | Displays images of a registered person (p. 61). |
|  Favorites | Displays images tagged as favorites (p. 148). |
|  Shot Date | Displays the images shot on a specific date. |
|  My Category | Displays the images of a specific category (p. 149). |
|  Still Image/Movie | Displays still images, movies, or movies shot in  mode. |

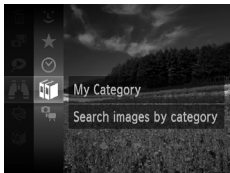

1 Choose a search condition.

- Press the button, choose in the menu, and choose a condition (p. 41).



2 View the image search results.

- Choose the type of images to view by pressing the , , , and buttons, and then press the button. (Except when searching images by .)
- ▶ Images matching the search conditions will display inside a yellow frame.
- Press the buttons to view image search results.
- Choose in step 1 to cancel image search.

-
- ⓘ ● When the camera has found no corresponding images for a search condition, those search conditions will not be available.



-
- Options for viewing images in a search result (step 2) include "Navigating Through Images in an Index" (p. 130), "Viewing Slideshows" (p. 136), and "Magnifying Images" (p. 135). You can protect, erase, or print all images in a search result at once by choosing "Select All Images in Search" in "Protecting Images" (p. 139), "Erasing All Images" (p. 143), "Adding Images to the Print List (DPOF)" (p. 188), or "Adding Images to a Photobook" (p. 192).
 - If you recategorize images (p. 149) or edit them and save them as new images (p. 152), a message is displayed and image search ends.

Viewing Movie Digest Movies

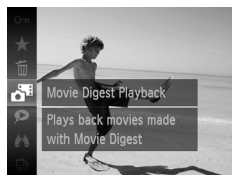
Movies created in  mode (p. 95) can be viewed by date.



1 Choose a movie.

- Press the  button, choose  in the menu, and choose the date (p. 41).

2 Play the movie.



- Press the  button to start playback.

Viewing Individual Images in a Group

Grouped images shot in  mode (p. 100) are generally displayed together, but they can also be viewed individually.



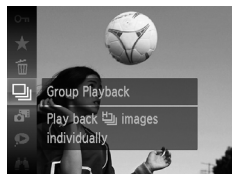

1 Choose an image group.

- Press the   buttons to choose an image labeled .





2 Choose .



- Press the  button, and then choose  in the menu (p. 41).



3 View individual images in the group.

- Pressing the ◀▶ buttons will display only images in the group.
- To cancel group playback, press the  button, choose  in the menu, and press the  button again (p. 41).



- During group playback (step 3), you can use the menu functions accessed by pressing the  button. You can also browse through images quickly (“Navigating Through Images in an Index” (p. 130)) and magnify them (“Magnifying Images” (p. 135)). You can protect, erase, or print all images in a group at once by choosing “All Images in Group” in “Protecting Images” (p. 139), “Erasing All Images” (p. 143), “Adding Images to the Print List (DPOF)” (p. 188), or “Adding Images to a Photobook” (p. 192).
- To ungroup images so that you can view them individually, press the **MENU** button, choose [Group Images] on the  tab, and then choose [Off] (p. 42). However, grouped images cannot be ungrouped during individual playback.

Still Images

Editing Face ID Information



If you notice that a name is incorrect during playback, you can change it or erase it.

However, you cannot add names for people who are not detected by Face ID (names are not displayed), and for people whose names have been erased.

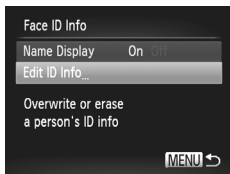
Changing Names



1 Access the setting screen.

- Press the **MENU** button and choose [Face ID Info] on the  tab (p. 42).
- Press the ▲▼ buttons to choose [Edit ID Info], and then press the  button.



2 Choose an image.

- Follow the procedure on p. 127 to choose an image, and then press the **FUNC SET** button.
- An orange frame is displayed around the selected face. When multiple names are displayed in an image, press the **◀▶** buttons to choose the name to change, and press the **FUNC SET** button.

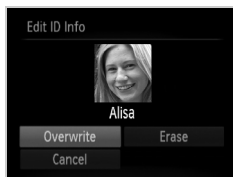

3 Choose the item to edit.

- Press the **▲▼◀▶** buttons to choose [Overwrite], and then press the **FUNC SET** button.

4 Choose the name of the person to change.

- Follow step 2 on p. 67 to choose the name of the person you want to change.

Erasing Names

- Choose [Erase] on the screen in step 3 above, and press the **FUNC SET** button.
- After [Erase?] is displayed, press the **◀▶** buttons to choose [OK], and then press the **FUNC SET** button.

Magnifying Images

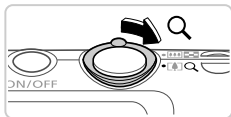

Approximate Position of Displayed Area

1 Magnify an image.

- Moving the zoom lever toward Q will zoom in and magnify the image, and SET is displayed. You can magnify images up to about 10x by continuing to hold the zoom lever.
- To zoom out, move the zoom lever toward . You can return to single-image display by continuing to hold it.

2 Move the display position and switch images as needed.

- To move the display position, press the buttons.
- While SET is displayed, you can switch to SET by pressing the FUNC SET button. To switch to other images while zoomed, press the buttons. Press the FUNC SET button again to restore the original setting.





- You can return to single-image display from magnified display by pressing the MENU button.

Viewing Slideshows

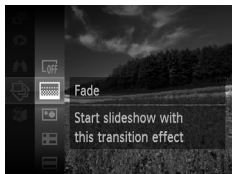
Automatically play back images from a memory card as follows. Each image is displayed for about three seconds.







Choose a slideshow transition and start playback.

- Press the  button, choose  in the menu, and choose the desired option (p. 41).
- ▶ The slideshow will start a few seconds after [Loading image...] is displayed.
- Press the **MENU** button to stop the slideshow.



- The camera's power-saving functions (p. 38) are deactivated during slideshows.



- To pause or resume slideshows, press the  button.
- You can switch to other images during playback by pressing the   buttons. For fast-forward or fast-rewind, hold the   buttons down.
- In image search mode (p. 130), only images matching search conditions are played.

Changing Slideshow Settings

You can set up slideshows to repeat, and you can change the transitions between images and the display duration of each image. Choose from six transition effects between images.

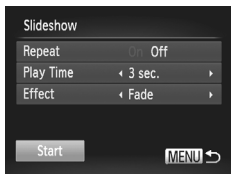

1 Access the setting screen.

- Press the **MENU** button and choose [Slideshow] on the tab (p. 42).

2 Configure the settings.

- Choose a menu item to configure, and then choose the desired option (p. 42).
- To start the slideshow with your settings, choose [Start] and press the button.
- To return to the menu screen, press the **MENU** button.



- [Play Time] cannot be modified when [Bubble] is chosen in [Effect].

Still Images

Auto Playback of Similar Images (Smart Shuffle)

Based on the current image, the camera offers four images similar to it that you may wish to view. After you choose to view one of those images, the camera offers four more images. This is an enjoyable way to play back images in an unexpected order. Try this feature after you have taken many shots, in many kinds of scenes.

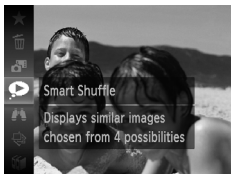



1 Choose Smart Shuffle.

- Press the button, and then choose in the menu (p. 41).
- ▶ Four candidate images are displayed.



2 Choose an image.

- Press the ▲▼◀▶ buttons to choose the image you want to view next.
- ▶ Your chosen image is displayed in the center, surrounded by the next four candidate images.
- For full-screen display of the center image, press the  button. To restore the original display, press the  button again.
- Press the **MENU** button to restore single-image display.



- Only still images shot with this camera are played back using Smart Shuffle.
- [Smart Shuffle] is not available in the following cases:
 - There are less than 50 shots taken with this camera
 - An unsupported image is currently displayed
 - When using the image search function (p. 130)
 - During group playback (p. 132)

Protecting Images

Protect important images to prevent accidental erasure by the camera (p. 143).



- Press the **FUNC. SET** button, and then choose **Protect** in the menu (p. 41). [Protected] is displayed.
- To cancel protection, repeat this process and choose **Protect** again, and then press the **FUNC. SET** button.



- Protected images on a memory card will be erased if you format the card (pp. 164, 165).



- Protected images cannot be erased by the camera. To erase them, cancel protection settings first.

Using the Menu



1 Access the setting screen.

- Press the **MENU** button, and then choose [Protect] on the **▶** tab (p. 42).

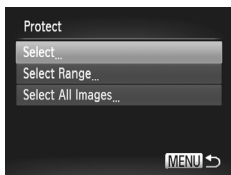

2 Choose a selection method.

- Choose a menu item and a setting as desired (p. 42).
- To return to the menu screen, press the **MENU** button.







Choosing Images Individually

1 Choose [Select].

- Following step 2 on p. 139, choose [Select] and press the  button.





2 Choose an image.

- Press the   buttons to choose an image, and then press the  button.  is displayed.
- To cancel protection, press the  button again.  is no longer displayed.
- Repeat this process to specify other images.



3 Protect the images.

- Press the **MENU** button. A confirmation message is displayed.
- Press the   buttons to choose [OK], and then press the  button.



- Images will not be protected if you switch to Shooting mode or turn the camera off before finishing the setup process in step 3.

Selecting a Range

1 Choose [Select Range].

- Following step 2 on p. 139, choose [Select Range] and press the  button.





2 Choose a starting image.

- Press the  button.





- Press the  buttons to choose an image, and then press the  button.

3 Choose an ending image.

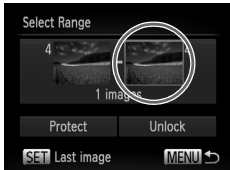
- Press the  button to choose [Last image], and then press the  button.



- Press the  buttons to choose an image, and then press the  button.
- Images before the first image cannot be selected as the last image.



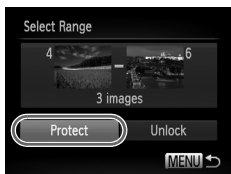

4 Protect the images.

- Press the ▼ button to choose [Protect], and then press the  button.

Specifying All Images at Once

1 Choose [Select All Images].

- Following step 2 on p. 139, choose [Select All Images] and press the  button.



2 Protect the images.

- Press the ▲▼ buttons to choose [Protect], and then press the  button.



- To cancel protection for groups of images, choose [Unlock] in step 4 of "Selecting a Range" or in step 2 of "Specifying All Images at Once".





Erasing Images

You can choose and erase unneeded images one by one. Be careful when erasing images, because they cannot be recovered.

1 Choose an image to erase.

- Press the ◀▶ buttons to choose an image.

2 Erase the image.

- Press the  button, and then choose  in the menu (p. 41).
- After [Erase?] is displayed, press the ◀▶ buttons to choose [Erase], and then press the  button.
 - ▶ The current image is now erased.
- To cancel erasure, press the ◀▶ buttons to choose [Cancel], and then press the  button.



Erasing All Images

You can erase all images at once. Be careful when erasing images, because they cannot be recovered. Protected images (p. 139) cannot be erased.

Choosing a Selection Method

1 Access the setting screen.

- Press the MENU button, and then choose [Erase] on the  tab (p. 42).

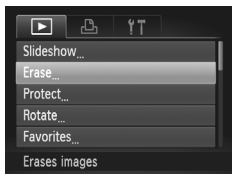

2 Choose a selection method.

- Choose a menu item and a setting as desired (p. 42).
- Press the ▲▼ buttons to choose a selection method, and then press the  button.
- To return to the menu screen, press the MENU button.

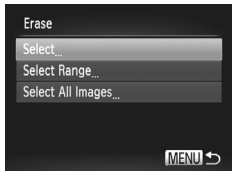

Choosing Images Individually

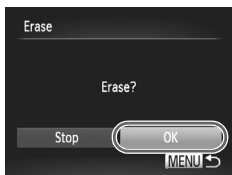

1 Choose [Select].

- Following step 2 on p. 143, choose [Select] and press the button.

2 Choose an image.

- Once you follow step 2 on p. 140 to choose an image, ✓ is displayed.
- To cancel erasure, press the button again. ✓ is no longer displayed.
- Repeat this process to specify other images.

3 Erase the image.

- Press the **MENU** button. A confirmation message is displayed.
- Press the buttons to choose [OK], and then press the button.

Selecting a Range

1 Choose [Select Range].

- Following step 2 on p. 143, choose [Select Range] and press the button.

2 Choose images.

- Follow steps 2 – 3 on p. 141 to specify images.



3 Erase the images.

- Press the button to choose [Erase], and then press the button.

■ Specifying All Images at Once

1 Choose [Select All Images].

- Following step 2 on p. 143, choose [Select All Images] and press the  button.

2 Erase the images.

- Press the ◀▶ buttons to choose [OK], and then press the  button.

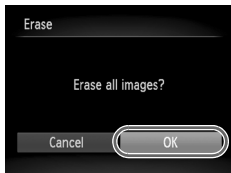

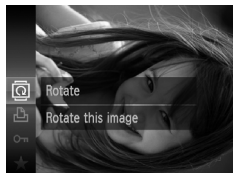

Rotating Images

Change the orientation of images and save them as follows.



1 Choose .

- Press the , and then choose  in the menu (p. 41).



2 Rotate the image.

- Press the ◀ or ▶ button, depending on the desired direction. Each time you press the button, the image is rotated 90°. Press the  button to complete the setting.

Using the Menu

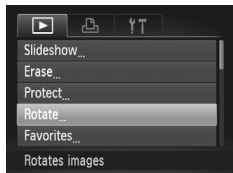



1 Choose [Rotate].

- Press the MENU button, and then choose [Rotate] on the  tab (p. 42).



2 Rotate the image.

- Press the ◀▶ buttons to choose an image.
- The image is rotated 90° each time you press the .
- To return to the menu screen, press the MENU button.

- ❗ Movies with an image quality of  or  cannot be rotated.
- Rotation is not possible when [Auto Rotate] is set to [Off] (p. 147).

Deactivating Auto Rotation

Follow these steps to deactivate automatic rotation by the camera, which rotates images shot in vertical orientation so they are displayed vertically on the camera.

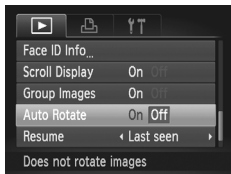

- Press the **MENU** button, choose [Auto Rotate] on the  tab, and then choose [Off] (p. 42).

- ⓘ Images cannot be rotated (p. 146) when you set [Auto Rotate] to [Off]. Additionally, images already rotated will be displayed in the original orientation.
- In Smart Shuffle (p. 137) mode, even if [Auto Rotate] is set to [Off], images shot vertically will be displayed vertically, and rotated images will be displayed in the rotated orientation.

Image Categories

You can tag images as favorites and assign them to My Category (p. 149). By choosing a category in image search, you can restrict the following operations to all of those images.

- Viewing (p. 126), Viewing Slideshows (p. 136), Protecting Images (p. 139), Erasing Images (p. 143), Adding Images to the Print List (DPOF) (p. 188), Adding Images to a Photobook (p. 192)

Tagging Images as Favorites

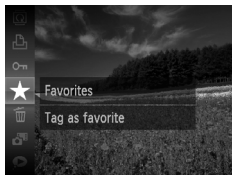

- Press the **FUNC/SET** button, and then choose **★** in the menu (p. 41).
- [Tagged as Favorite] is displayed.
- To untag the image, repeat this process and choose **★** again, and then press the **FUNC/SET** button.

Using the Menu



1 Choose [Favorites].

- Press the **MENU** button, and then choose [Favorites] on the **▶** tab (p. 42).



2 Choose an image.

- Press the **◀▶** buttons to choose an image, and then press the **FUNC/SET** button. **★** is displayed.
- To untag the image, press the **FUNC/SET** button again. **★** is no longer displayed.
- Repeat this process to choose additional images.



3 Finish the setup process.



- Press the **MENU** button. A confirmation message is displayed.
- Press the ◀▶ buttons to choose [OK], and then press the  button.



! • Images will not be tagged as favorites if you switch to Shooting mode or turn the camera off before finishing the setup process in step 3.



 • Favorite images will have a three-star rating (★★★☆☆) when transferred to computers running Windows 7 or Windows Vista. (Does not apply to movies.)

Organizing Images by Category (My Category)

You can organize images into categories. Note that images are automatically categorized at the time of shooting, according to shooting conditions.



: Images with detected faces, or images shot in  or  mode.

: Images detected as , , or  in **AUTO** mode, or images shot in  mode.

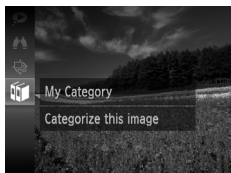
: Images shot in  or  mode.





1 Choose a category.

- Press the  button, and then choose  in the menu (p. 41).



2 Choose images.

- Press the ◀▶ buttons to choose an image, press the ▲▼ buttons to choose a category, and then press the  button. ✓ is displayed.
- To cancel selection, press the  button again. ✓ is no longer displayed.
- Repeat this process to specify other images.



3 Finish the setup process.

- Press the **MENU** button. A confirmation message is displayed.
- Press the ◀▶ buttons to choose [OK], and then press the  button.



- Images will not be assigned to a category if you switch to Shooting mode or turn the camera off before finishing the setup process in step 3.

Using the Menu

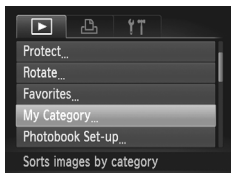

1 Access the setting screen.

- Press the **MENU** button, and then choose [My Category] on the  tab (p. 42).

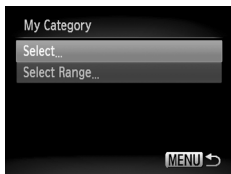

2 Choose a selection method.

- Choose a menu item and a setting as desired (p. 42).
- To return to the menu screen, press the **MENU** button.

Choosing Images Individually

1 Choose [Select].

- Following step 2 above, choose [Select] and press the  button.

2 Choose an image.

- Press the ◀▶ buttons to choose an image.



3 Choose a category.

- Press the ▲▼ buttons to choose a category, and then press the button. ✓ is displayed.
- To cancel selection, press the button again. ✓ is no longer displayed.
- Repeat this process to choose additional images.



4 Finish the setup process.

- Press the MENU button. A confirmation message is displayed. Press the ◀▶ buttons to choose [OK], and then press the button.

- Images will not be assigned to a category if you switch to Shooting mode or turn the camera off before finishing the setup process in step 4.

Selecting a Range

1 Choose [Select Range].

- Following step 2 on p. 150, choose [Select Range] and press the button.

2 Choose images.

- Follow steps 2 – 3 on p. 141 to specify images.



3 Choose a category.

- Press the ▼ button to choose the type of image, and then press the ◀▶ buttons to choose a category.

4 Finish the setup process.

- Press the ▼ button to choose [Select], and then press the button.



- You can clear the selection of all images in the [Select Range] category by choosing [Deselect] in step 4.

Editing Still Images

- ! Image editing (pp. 152 – 156) is only available when the memory card has sufficient free space.

Resizing Images

Save a copy of images at a lower resolution.

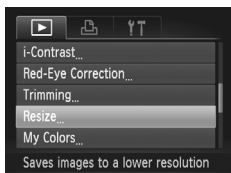

1 Choose [Resize].

- Press the **MENU** button, and then choose [Resize] on the tab (p. 42).

2 Choose an image.

- Press the buttons to choose an image, and then press the button.

3 Choose an image size.

- Press the buttons to choose the size, and then press the button.
- ▶ [Save new image?] is displayed.



4 Save the new image.

- Press the buttons to choose [OK], and then press the button.
- ▶ The image is now saved as a new file.

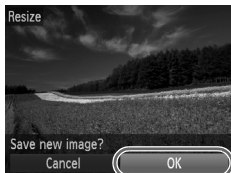

5 Review the new image.

- Press the **MENU** button. [Display new image?] is displayed.
- Press the buttons to choose [Yes], and then press the button.
- ▶ The saved image is now displayed.



- Editing is not possible for images saved as **XS** in step 3.



- Images cannot be resized to a higher resolution.

Cropping

You can specify a portion of an image to save as a separate image file.

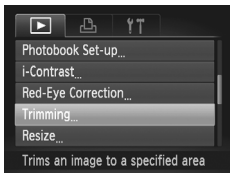

1 Choose [Trimming].

- Press the **MENU** button, and then choose [Trimming] on the tab (p. 42).

2 Choose an image.

- Press the buttons to choose an image, and then press the button.

3 Adjust the cropping area.

- ▶ A frame is displayed around the portion of the image to be cropped.
- ▶ The original image is shown in the upper left, and a preview of the image as cropped is shown in the lower right.
- To resize the frame, move the zoom lever.
- To move the frame, press the buttons.
- To change the frame orientation, press the button.
- Press the **MENU** button.

Cropping Area



Preview of Image After
Cropping
Resolution After Cropping



4 Save as a new image and review.

- Follow steps 4 – 5 on p. 152.

- ❗ Editing is not possible for images shot at a resolution of **S** (p. 72) or resized to **XS** (p. 152).



- Images supported for cropping will have the same aspect ratio after cropping.
- Cropped images will have a smaller resolution than uncropped images.
- If you crop still images shot using Face ID, only the names of the people left in the cropped image will remain.

Changing Image Color Tones (My Colors)

You can adjust image colors and then save the edited image as a separate file. For details on each option, see p. 112.

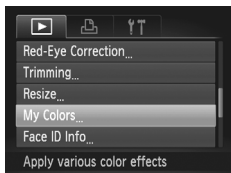

1 Choose [My Colors].

- Press the **MENU** button, and then choose [My Colors] on the tab (p. 42).

2 Choose an image.

- Press the buttons to choose an image, and then press the button.

3 Choose an option.

- Press the buttons to choose an option, and then press the button.

4 Save as a new image and review.

- Follow steps 4 – 5 on p. 152.



- ❗ Image quality of pictures you repeatedly edit this way will be a little lower each time, and you may not be able to obtain the desired color.



- The color of images edited using this function may vary slightly from the color of images shot using My Colors (p. 112).

Correcting Image Brightness (i-Contrast)

Excessively dark image areas (such as faces or backgrounds) can be detected and automatically adjusted to the optimal brightness. Insufficient overall image contrast is also automatically corrected, to make subjects stand out better. Choose from four correction levels, and then save the image as a separate file.

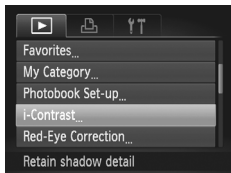

1 Choose [i-Contrast].

- Press the **MENU** button, and then choose [i-Contrast] on the tab (p. 42).

2 Choose an image.

- Press the buttons to choose an image, and then press the button.

3 Choose an option.

- Press the buttons to choose an option, and then press the button.

4 Save as a new image and review.

- Follow steps 4 – 5 on p. 152.



- For some images, correction may be inaccurate or may cause images to appear grainy.
- Images may look grainy after repeated editing using this function.



- If [Auto] does not produce the expected results, try correcting images using [Low], [Medium], or [High].

Correcting Red-Eye

Automatically corrects images affected by red-eye. You can save the corrected image as a separate file.

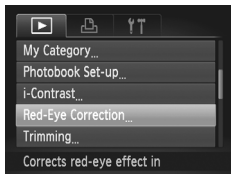

1 Choose [Red-Eye Correction].

- Press the **MENU** button, and then choose [Red-Eye Correction] on the tab (p. 42).

2 Choose an image.

- Press the buttons to choose an image.

3 Correct the image.

- Press the button.
- ▶ Red-eye detected by the camera is now corrected, and frames are displayed around corrected image areas.
- Enlarge or reduce images as needed. Follow the steps in “Magnifying Images” (p. 135).



4 Save as a new image and review.

- Press the buttons to choose [New File], and then press the button.
- ▶ The image is now saved as a new file.
- Follow step 5 on p. 152.

- ! Some images may not be corrected accurately.
- To overwrite the original image with the corrected image, choose [Overwrite] in step 4. In this case, the original image will be erased.
- Protected images cannot be overwritten.

Editing Movies

You can cut movies to remove unneeded portions at the beginning or end.

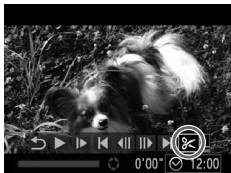

Movie Editing Panel



Movie Editing Bar

1 Choose ✂.

- Following steps 1 – 3 on pp. 126 – 127, choose ✂ and press the **FUNC SET** button.
- ▶ The movie editing panel and editing bar are now displayed.

2 Specify portions to cut.



- Press the ▲▼ buttons to choose ⏪ or ⏩.
- To view the portions you can cut (identified by ✂ on the screen), press the ◀▶ buttons to move ▾. Cut the beginning of the movie (from ✂) by choosing ⏪, and cut the end of the movie by choosing ⏩.
- Even if you move ▾ to a position other than a ✂ mark, choosing ⏪ will only cut the portion from the nearest ✂ to the left, and choosing ⏩ will cut the portion from the nearest ✂ to the right.

3 Review the edited movie.

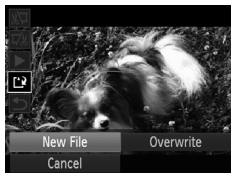
- Press the ▲▼ buttons to choose ▶, and then press the **FUNC SET** button. The edited movie is now played.
- To edit the movie again, repeat step 2.
- To cancel editing, press the ▲▼ buttons to choose ↶. Press the **FUNC SET** button, press the ◀▶ buttons to choose [OK], and then press the **FUNC SET** button again.



4 Save the edited movie.

- Press the ▲▼ buttons to choose [↵], and then press the  button.
- Press the ◀▶ buttons to choose [New File], and then press the  button.
- ▶ The movie is now saved as a new file.



- To overwrite the original movie with the cut one, choose [Overwrite] in step 4. In this case, the original movie will be erased.
- [Overwrite] is only available when memory cards lack sufficient free space.
- Movies may not be saved if the battery runs out while saving is in progress.
- When editing movies, you should use a fully charged battery or an AC adapter kit (sold separately, p. 173).

6

Setting Menu

Customize or adjust basic camera functions for greater convenience

Adjusting Basic Camera Functions

Functions can be configured on the **Y/T** tab. Customize commonly used functions as desired, for greater convenience (p. 42).

Silencing Camera Operations

Silence camera sounds and movies as follows.



- Choose [Mute], and then choose [On].



- Operation can also be silenced by holding down the **▼** button as you turn the camera on.
- Sound is not played during movies if you mute camera sounds (p. 126). To restore sound during movies, press the **▲** button. Adjust volume with the **▲▼** buttons, as needed.

Adjusting the Volume

Adjust the volume of individual camera sounds as follows.

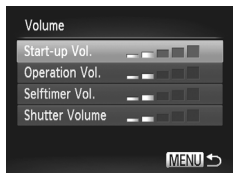



- Choose [Volume], and then press the **FUNC/SET** button.
- Choose an item, and then press the **◀▶** buttons to adjust the volume.

Customizing Sounds

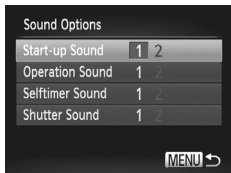
Customize camera operating sounds as follows.



- Choose [Sound Options], and then press the  button.
- Choose an item, and then press the  buttons to choose an option.

| | |
|---|---|
| 1 | Preset sounds (cannot be modified) |
| 2 | Preset sounds Can be changed by using the included software. |



- The default shutter sound is used in  mode (p. 100), regardless of any changes to [Shutter Sound].

Hiding Hints and Tips

Hints and tips are normally shown when you choose FUNC. menu (p. 41) or Menu (p. 42) items. If you prefer, you can deactivate this information.



- Choose [Hints & Tips], and then choose [Off].

Screen Brightness

Adjust screen brightness as follows.



- Choose [LCD Brightness], and then press the ◀▶ buttons to adjust the brightness.





- For maximum brightness, press and hold the ▼ button for at least one second when the shooting screen is displayed or when in single-image display. (This will override the [LCD Brightness] setting on the ⏏ tab.) To restore the original brightness, press and hold the ▼ button again for at least one second or restart the camera.

Start-up Screen

Customize the start-up screen shown after you turn the camera on as follows.



- Choose [Start-up Image], and then press the  button.
- Press the ◀▶ buttons to choose an option.

| | |
|---|--|
|  | No start-up image |
| 1 | Preset images (cannot be modified) |
| 2 | Preset images Assign desired shots, or use the included software to change the image. |

Customizing the Start-up Screen

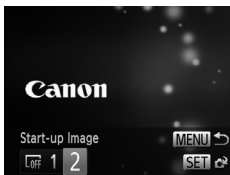

1 Access the [Start-up Image] screen in Playback mode.

- Press the button.
- Following the steps on p. 162, choose [2] and press the button.



2 Choose one of your shots.

- Choose an image and press the button. After [Register?] is displayed, press the buttons to choose [OK], and then press the button.

-
- ! The previous start-up setting is overwritten when you assign a new start-up image.

-
- You can assign the operating sounds and start-up images for your camera from the included software. For details, refer to the *ImageBrowser EX User Guide*.

Formatting Memory Cards

Before using a new memory card or a card formatted in another device, you should format the card with this camera.

Formatting erases all data on a memory card. Before formatting, copy images on the memory card to a computer, or take other steps to back them up.

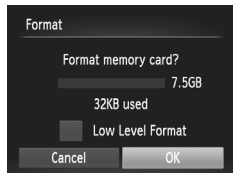

An Eye-Fi card (p. 194) contains software on the card itself. Before formatting an Eye-Fi card, install the software on a computer.



1 Access the [Format] screen.



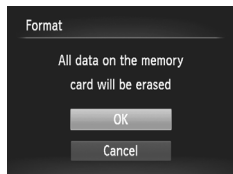

- Choose [Format], and then press the  button.

2 Choose [OK].

- Press the   buttons to choose [OK], and then press the  button.



3 Format the memory card.

- To begin the formatting process, press the   buttons to choose [OK], and then press the  button.
- When formatting is finished, [Memory card formatting complete] is displayed. Press the  button.



- Formatting or erasing data on a memory card only changes file management information on the card and does not erase the data completely. When transferring or disposing of memory cards, take steps to protect personal information if necessary, as by physically destroying cards.



- The total card capacity indicated on the formatting screen may be less than the advertised capacity.

Low-Level Formatting

Perform low-level formatting in these cases: [Memory card error] is displayed, the camera is not working correctly, card image reading/writing is slower, continuous shooting is slower, or movie recording suddenly stops. Low-level formatting erases all data on a memory card. Before low-level formatting, copy images on the memory card to a computer, or take other steps to back them up.

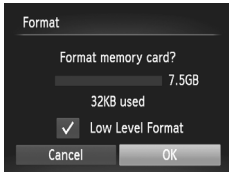

Perform low-level formatting.

- On the screen in step 1 on p. 164, press the ▲▼ buttons to choose [Low Level Format], and then select this option (mark with a ✓) by pressing the ◀▶ buttons.
- Press the ▲▼◀▶ buttons to choose [OK], press the  button, and then follow step 3 on p. 164 to format (low-level format) the memory card.



- Low-level formatting takes longer than “Formatting Memory Cards” (p. 164), because data is erased from all storage regions of the memory card.
- You can cancel low-level formatting in progress by choosing [Stop]. In this case, all data will be erased, but the memory card can be used normally.

File Numbering

Your shots are automatically numbered in sequential order (0001 – 9999) and saved in folders that store up to 2,000 images each. You can change how the camera assigns file numbers.



- Choose [File Numbering], and then choose an option.

| | |
|------------|---|
| Continuous | Images are numbered consecutively (until the 9999th shot is taken/saved) even if you switch memory cards. |
| Auto Reset | Image numbering is reset to 0001 if you switch memory cards, or when a new folder is created. |



- Regardless of the option selected in this setting, shots may be numbered consecutively after the last number of existing images on newly inserted memory cards. To start saving shots from 0001, use an empty (or formatted (p. 164)) memory card.
- Refer to the *ImageBrowser EX User Guide* for information on the card folder structure and image formats.



Date-Based Image Storage

Instead of saving images in folders created each month, you can have the camera create folders each day you shoot to store shots taken that day.



- Choose [Create Folder], and then choose [Daily].
 - ▶ Images will now be saved in folders created on the shooting date.

Lens Retraction Timing

The lens is normally retracted for safety about one minute after you press the  button in Shooting mode (p. 38). To have the lens retracted immediately after you press the  button, set the retraction timing to [0 sec.].

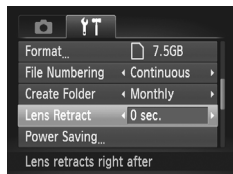

- Choose [Lens Retract], and then choose [0 sec.].

Power-Saving Adjustment

Adjust the timing of automatic camera and screen deactivation (Auto Power Down and Display Off, respectively) as needed (p. 38).

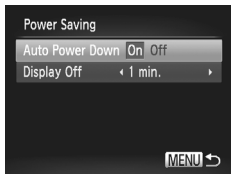

1 Access the [Power Saving] screen.

- Choose [Power Saving], and then press the  button.

2 Configure the settings.

- After choosing an item, press the  buttons to adjust it as needed.



- To conserve battery power, you should normally choose [On] for [Auto Power Down] and [1 min.] or less for [Display Off].



- The [Display Off] setting is applied even if you set [Auto Power Down] to [Off].







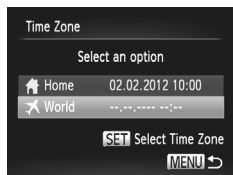

World Clock

To ensure that your shots will have the correct local date and time when you travel abroad, simply register the destination in advance and switch to that time zone. This convenient feature eliminates the need to change the Date/Time setting manually.

Before using the world clock, be sure to set the date and time (p. 17) and your home time zone.





1 Specify your destination.

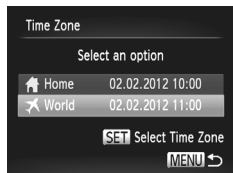

- Choose [Time Zone], and then press the  button.
- Press the  buttons to choose [ World], and then press the  button.
- Press the  buttons to choose the destination.
- To set daylight saving time (1 hour ahead), press the  buttons to choose .
- Press the  button.



2 Switch to the destination time zone.

- Press the  buttons to choose [ World], and then press the **MENU** button.
- ▶  is now shown on the shooting screen (p. 204).



- Adjusting the date or time while in  mode (p. 18) will automatically update your [ Home] time and date.

Date and Time

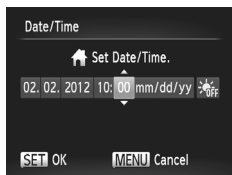

Adjust the date and time as follows.



1 Access the [Date/Time] screen.

- Choose [Date/Time], and then press the  button.

2 Configure the settings.

- Press the  buttons to choose an item, and then press the  buttons to adjust the setting.

Display Language



Change the display language as needed.



1 Access the [Language] screen.

- Choose [Language ], and then press the  button.

2 Configure the setting.

- Press the  buttons to choose a language, and then press the  button.



- You can also access the [Language] screen in Playback mode by pressing and holding the  button and immediately pressing the MENU button.

Adjusting Other Settings

The following settings can also be adjusted on the  tab.

- [Video System] (p. 176)
- [Ctrl via HDMI] (p. 177)
- [Eye-Fi Settings] (p. 194)

Restoring Defaults

If you accidentally change a setting, you can restore default camera settings.

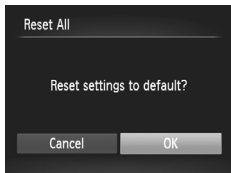



1 Access the [Reset All] screen.

- Choose [Reset All], and then press the  button.

2 Restore default settings.

- Press the ◀▶ buttons to choose [OK], and then press the  button.
- ▶ Default settings are now restored.



- The following functions are not restored to default settings.
 -  tab settings [Date/Time] (p. 18), [Language]  (p. 19), [Time Zone] (p. 168), [Video System] (p. 176), and the image assigned to [Start-up Image] (p. 162)
 - Information registered using Face ID (p. 61)
 - Shooting mode you specified when the mode switch was set to  (p. 81)
 - Colors chosen in Color Accent (p. 92) or Color Swap (p. 93)
 - Custom white balance data you have recorded (p. 111)

7

Accessories

Use included accessories effectively and enjoy the camera in more ways with optional Canon accessories and other compatible accessories sold separately

Effective Battery and Charger Use

- **Charge the battery on (or immediately before) the day of use**

Charged batteries gradually lose their charge, even when they are not used.

You can easily check the charge state of the battery by attaching the cover so that ▲ is visible on a charged battery, and attaching it so that ▲ is not visible on an uncharged battery.

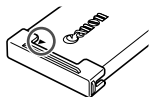

- **Long-term battery storage**

After using up all remaining battery power, remove the battery from the camera. Store the battery with the cover attached. Storing a partially charged battery over extended periods (about a year) may shorten its life or affect performance.

- **Using the battery charger abroad**

The charger can be used in areas with 100 – 240 V AC power (50/60 Hz). For power outlets in a different format, use a commercially available adapter for the plug. Never use an electrical transformer designed for traveling, which may damage the battery.

Optional Accessories

The following camera accessories are sold separately. Note that availability varies by area, and some accessories may no longer be available.

Power Supplies

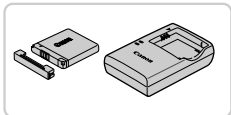

Battery Pack NB-11L

- Rechargeable lithium-ion battery

Battery Charger CB-2LD/CB-2LDE

- Charger for Battery Pack NB-11L

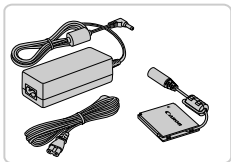

AC Adapter Kit ACK-DC90

- For powering the camera using household power. Recommended when using the camera over extended periods, or when connecting the camera to a printer or computer. Cannot be used to charge the camera battery.



- The battery charger and AC adapter kit can be used in areas with 100 – 240 V AC power (50/60 Hz).
- For power outlets in a different format, use a commercially available adapter for the plug. Never use an electrical transformer designed for traveling, which may damage the battery.

Flash Units



High-Power Flash HF-DC2

- External flash for illuminating subjects that are out of range of the built-in flash.

Other Accessories

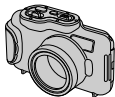

Waterproof Case WP-DC330L

- For underwater photography at depths of up to 3 meters (9.8 ft.). Also useful for shooting in the rain, at the beach, or on ski slopes.

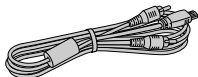

AV Cable AVC-DC400

- Connect the camera to a TV to enjoy playback on the larger TV screen.

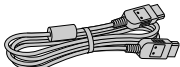

HDMI Cable HTC-100

- For connecting the camera to an HDMI input of a high-definition TV.

Printers



SELPHY
Series



Inkjet Printers

Canon PictBridge-Compatible Printers

- Printing images without a computer is possible by connecting the camera to a Canon PictBridge-compatible printer. For details, visit your nearest Canon dealer.

Playback on a TV

By connecting the camera to a TV, you can view your shots on the larger screen of the TV.

For details on connection or how to switch inputs, refer to the TV manual.



- Some information may not be displayed when viewing images on a TV (p. 206).

Playback on a Standard-Definition TV

Connecting the camera to a TV with the AV Cable AVC-DC400 (sold separately) enables you to view your shots on the larger screen of the TV as you control the camera.

1 Make sure the camera and TV are off.

2 Connect the camera to the TV.

- On the TV, insert the cable plugs fully into the video inputs as shown.
- On the camera, open the terminal cover and insert the cable plug fully into the camera terminal.

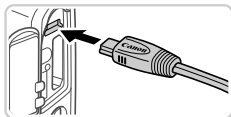
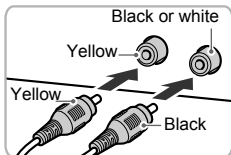

3 Turn the TV on and switch to video input.

- Switch the TV input to the video input you connected the cable to in step 2.

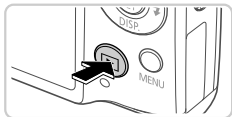

4 Turn the camera on.

- Press the  button to turn the camera on.
- ▶ Images from the camera are now displayed on the TV. (Nothing is displayed on the camera screen.)
- When finished, turn off the camera and TV before disconnecting the cable.





- Correct display is not possible unless the camera video output format (NTSC or PAL) matches the TV format. To change the video output format, press the **MENU** button and choose [Video System] on the  tab.



- When the camera and TV are connected, you can also shoot while previewing shots on the larger screen of the TV. To shoot, follow the same steps as when using the camera screen.

■ Playback on a High-Definition TV

Connecting the camera to an HDTV with the HDMI Cable HTC-100 (sold separately) enables you to view your shots on the larger screen of the TV. Movies shot at a resolution of  or  can be viewed in high-definition.

1 Make sure the camera and TV are off.

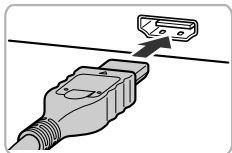

2 Connect the camera to the TV.

- On the TV, insert the cable plug fully into the HDMI input as shown.
- On the camera, open the terminal cover and insert the cable plug fully into the camera terminal.

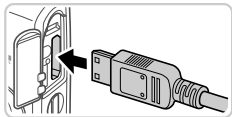

3 Display images.

- Follow steps 3 – 4 on pp. 175 – 176 to display images.



- It is not possible to connect the included interface cable or an optional AV cable at the same time as an HDMI Cable HTC-100. Forcing the cables into the camera at the same time may damage the camera or cables.



- Camera operating sounds are not played while the camera is connected to an HDTV.

Controlling the Camera with a TV Remote

Connecting the camera to an HDMI CEC-compatible TV enables playback (including slideshow playback) using the TV remote control.

In this case, you will need to adjust some TV settings. For details, refer to the TV user manual.

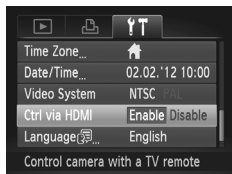

1 Configure the settings.

- Press the **MENU** button, choose [Ctrl via HDMI] on the **YT** tab, and then choose [Enable] (p. 42).

2 Connect the camera to the TV.

- Follow steps 1 – 2 on p. 176 to connect the camera to the TV.







3 Display images.

- Turn on the TV. On the camera, press the **▶** button.
- ▶ Images from the camera are now displayed on the TV. (Nothing is displayed on the camera screen.)

4 Control the camera with the TV remote.

- Press the ◀▶ buttons on the remote to browse images.
- To display the camera control panel, press the OK/Select button. Select control panel items by pressing the ◀▶ buttons to choose an item, and then pressing the OK/Select button again.

■ Camera Control Panel Options Shown on the TV

| | |
|---|---|
|  Return | Closes the menu. |
|  Group Playback | Displays sets of images shot in  mode (p. 100). (Only displayed when a grouped image is selected.) |
|  Play Movie | Starts movie playback. (Only displayed when a movie is selected.) |
|  Slideshow | Starts slideshow playback. To switch images during playback, press the ◀▶ buttons on the remote control. |
|  Index Playback | Displays multiple images in an index. |
| DISP. Change Display | Switches display modes (p. 40). |



- Pressing any buttons on the camera will switch control to the camera itself, which will prevent remote control until you return to single-image display.
- The camera may not always respond correctly even if the remote is for an HDMI CEC-compatible TV.

Powering the Camera with Household Power

Powering the camera with AC Adapter Kit ACK-DC90 (sold separately) eliminates the need to monitor the remaining battery level.

1 Make sure the camera is off.

Coupler Cable Port

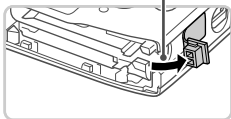

2 Open the cover.

- Follow step 2 on p. 15 to open the memory card/battery cover.
- Open the coupler cable port as shown.

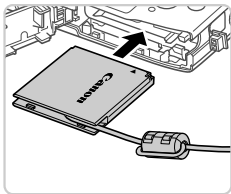

3 Insert the coupler.

- Insert the coupler as shown.

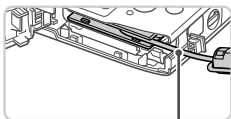

- Make sure the coupler cable passes through the port.

Cable

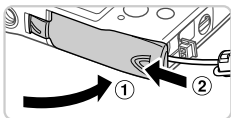

4 Close the cover.

- Lower the cover (①) and hold it down as you slide it, until it clicks into the closed position (②).

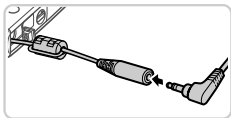

5 Connect the power cord.

- Insert the adapter plug into the end of the coupler cable.

Using Optional Accessories

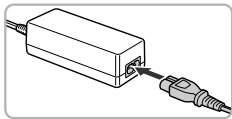

- Insert one end of the power cord into the compact power adapter, and then plug the other end into a power outlet.
- Turn the camera on and use it as desired.
- When finished, turn the camera off and unplug the power cord from the outlet.



- Do not disconnect the adapter or unplug the power cord while the camera is still on. This may erase your shots or damage the camera.
- Do not attach the adapter or adapter cord to other objects. Doing so could result in malfunction or damage to the product.

Printing Images

Your shots can easily be printed by connecting the camera to a printer. On the camera, you can specify images to set up batch printing, prepare orders for photo development services, and prepare or print images for photobooks. A Canon SELPHY CP series compact photo printer is used here for the sake of illustration. Screens displayed and available functions vary by printer. Also refer to the printer manual for additional information.

Easy Print

Easily print your shots by connecting the camera to a PictBridge-compatible printer (sold separately) with the included interface cable (p. 2).

- 1 Make sure the camera and printer are off.**

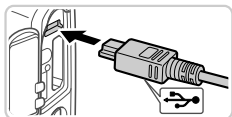

- 2 Connect the camera to the printer.**

- Open the cover. Holding the smaller cable plug in the orientation shown, insert the plug fully into the camera terminal.
- Connect the larger cable plug to the printer. For other connection details, refer to the printer manual.

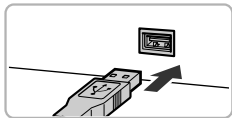

- 3 Turn the printer on.**

- 4 Turn the camera on.**

- Press the  button to turn the camera on.

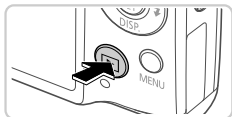



- 5 Choose an image.**

- Press the  buttons to choose an image.





6 Access the printing screen.

- Press the  button, choose , and press the  button again.



7 Print the image.

- Press the   buttons to choose [Print], and then press the  button.
- ▶ Printing now begins.
- To print other images, repeat steps 5 – 6 after printing is finished.
- When you are finished printing, turn the camera and printer off and disconnect the interface cable.



- For Canon PictBridge-compatible printers (sold separately), see p. 174.

Configuring Print Settings





1 Access the printing screen.

- Follow steps 1 – 6 on pp. 181 – 182 to access the screen at left.

2 Configure the settings.

- Press the ▲▼ buttons to choose an item, and then press the ◀▶ buttons to choose an option.

| | | |
|---|---------------|---|
|  | Default | Matches current printer settings. |
| | Date | Prints images with the date added. |
| | File No. | Prints images with the file number added. |
| | Both | Prints images with both the date and file number added. |
| | Off | – |
|  | Default | Matches current printer settings. |
| | Off | – |
| | On | Uses information from the time of shooting to print under optimal settings. |
| | Red-Eye 1 | Corrects red-eye. |
|  | No. of Copies | Choose the number of copies to print. |
| Trimming | – | Specify a desired image area to print (p. 184). |
| Paper Settings | – | Specify the paper size, layout, and other details (p. 185). |

Cropping Images Before Printing (Trimming)

By cropping images before printing, you can print a desired image area instead of the entire image.

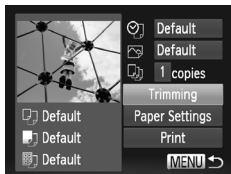









1 Choose [Trimming].

- After following step 1 on p. 183 to access the printing screen, choose [Trimming] and press the  button.
- ▶ A cropping frame is now displayed, indicating the image area to print.



2 Adjust the cropping frame as needed.

- To resize the frame, move the zoom lever.
- To move the frame, press the     buttons.
- To rotate the frame, press the  button.
- Press the **MENU** button, press the   buttons to choose [OK], and then press the  button.

3 Print the image.

- Follow step 7 on p. 182 to print.



- Cropping may not be possible at small image sizes, or at some aspect ratios.
- Dates may not be printed correctly if you crop images shot with [Date Stamp] selected.

Choosing Paper Size and Layout Before Printing



1 Choose [Paper Settings].

- After following step 1 on p. 183 to access the printing screen, choose [Paper Settings] and press the button.

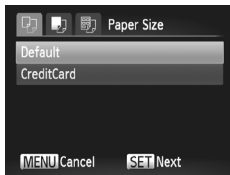

2 Choose a paper size.

- Press the to choose an option, and then press the .

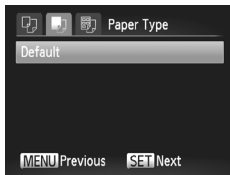

3 Choose a type of paper.

- Press the to choose an option, and then press the .

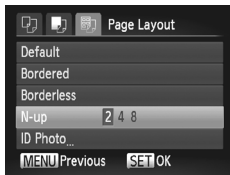

4 Choose a layout.

- Press the to choose an option.
- When choosing [N-up], press the to specify the number of images per sheet.
- Press the .

5 Print the image.

Available Layout Options

| | |
|------------|--|
| Default | Matches current printer settings. |
| Bordered | Prints with blank space around the image. |
| Borderless | Borderless, edge-to-edge printing. |
| N-up | Choose how many images to print per sheet. |
| ID Photo | Prints images for identification purposes. Only available for images with a resolution of L and an aspect ratio of 4:3. |
| Fixed Size | Choose the print size. Choose from 3.5 x 5 in., postcard, or wide-format prints. |

Printing ID Photos

1 Choose [ID Photo].

- Following steps 1 – 4 on p. 185, choose [ID Photo] and press the  button.

2 Choose the long and short side length.

- Press the ▲▼ buttons to choose an item. Choose the length by pressing the ◀▶ buttons, and then press the  button.

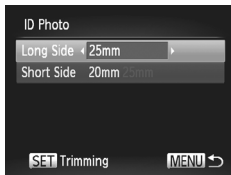

3 Choose the printing area.

- Follow step 2 on p. 184 to choose the printing area.

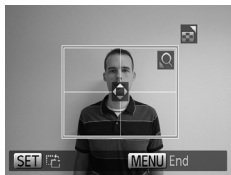

4 Print the image.

Printing Movie Scenes

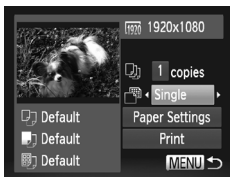

1 Access the printing screen.

- Follow steps 1 – 6 on pp. 181 – 182 to choose a movie. The screen at left is displayed.

2 Choose a printing method.

- Press the ▲▼ buttons to choose , and then press the ◀▶ buttons to choose the printing method.

3 Print the image.

Movie Printing Options

| | |
|----------|--|
| Single | Prints the current scene as a still image. |
| Sequence | Prints a series of scenes, a certain interval apart, on a single sheet of paper. You can also print the folder number, file number, and elapsed time for the frame by setting [Caption] to [On]. |



- To cancel printing in progress, press the  button.
- [ID Photo] and [Sequence] are not available with Canon PictBridge-compatible printer models earlier than CP720 and CP730.

Adding Images to the Print List (DPOF)

Batch printing (p. 191) and ordering prints from a photo development service can be set up on the camera. Choose up to 998 images on a memory card and configure relevant settings, such as the number of copies, as follows. The printing information you prepare this way will conform to DPOF (Digital Print Order Format) standards.

Adding Images to the Print List via the FUNC. Menu



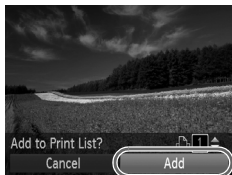

You can add images to the print list (DPOF) after your shot or later during playback via the FUNC. menu.

1 Choose an image.

- Press the ◀▶ buttons to choose an image.





2 Add the image to the print list.

- Press the  button, choose  in the menu, and press the  button again.
- Press the ▲▼ buttons to specify the number of prints. Choose [Add] by pressing the ◀▶ buttons, and then press the  button.

Configuring Print Settings

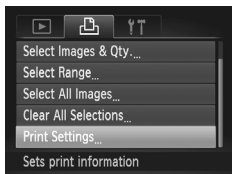
Specify the printing format, whether to add the date or file number, and other settings as follows. These settings apply to all images in the print list.



- Press the MENU button, and then choose [Print Settings] on the  tab. Choose and configure settings as desired (p. 42).

| | | |
|------------------------|----------|--|
| Print Type | Standard | One image is printed per sheet. |
| | Index | Smaller versions of multiple images are printed per sheet. |
| | Both | Both standard and index formats are printed. |
| Date | On | Images are printed with the shooting date. |
| | Off | – |
| File No. | On | Images are printed with the file number. |
| | Off | – |
| Clear DPOF data | On | All image print list settings are cleared after printing. |
| | Off | – |



- Not all of your DPOF settings may be applied in printing by the printer or photo development service, in some cases.
-  may be displayed on the camera to warn you that the memory card has print settings that were configured on another camera. Changing the print settings using this camera may overwrite all previous settings.
- Setting [Date] to [On] may cause some printers to print the date twice.



- Specifying [Index] will prevent you from choosing [On] for both [Date] and [File No.] at the same time.
- The date is printed in a format matching setting details in [Date/Time] on the  tab, accessible by pressing the **MENU** button (p. 17).
- Index printing is not available on some Canon PictBridge-compatible printers (sold separately).

Setting Up Printing for Individual Images

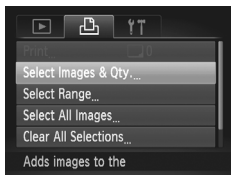

1 Choose [Select Images & Qty.].

- Press the **MENU** button, choose [Select Images & Qty.] on the tab, and then press the button.

2 Choose an image.

- Press the buttons to choose an image, and then press the button.
- ▶ You can now specify the number of copies.
- If you specify index printing for the image, it is labeled with a icon. To cancel index printing for the image, press the button again. is no longer displayed.



3 Specify the number of prints.

- Press the buttons to specify the number of prints (up to 99).
- To set up printing for other images and specify the number of prints, repeat steps 2 - 3.
- Printing quantity cannot be specified for index prints. You can only choose which images to print, by following step 2.
- When finished, press the **MENU** button to return to the menu screen.

Setting Up Printing for a Range of Images

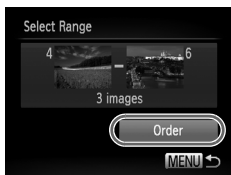

1 Choose [Select Range].

- Following step 1 above, choose [Select Range] and press the button.

2 Choose images.

- Follow steps 2 – 3 on p. 141 to specify images.

3 Configure the print settings.

- Press the ▲▼ buttons to choose [Order], and then press the  button.

Setting Up Printing for All Images



1 Choose [Select All Images].

- Following step 1 on p. 190, choose [Select All Images] and press the  button.

2 Configure the print settings.

- Press the ◀▶ buttons to choose [OK], and then press the  button.

Clearing All Images from the Print List

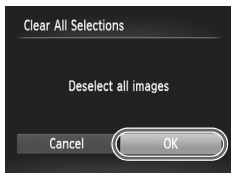

1 Choose [Clear All Selections].

- Following step 1 on p. 190, choose [Clear All Selections] and press the  button.

2 Confirm clearing the print list.

- Press the ◀▶ buttons to choose [OK], and then press the  button.

Printing Images Added to the Print List (DPOF)





- When images have been added to the print list (pp. 188 – 191), the screen at left is displayed after you connect the camera to a PictBridge-compatible printer. Press the ▲▼ buttons to choose [Print now], and then simply press the  button to print the images in the print list.
- Any DPOF print job that you temporarily stop will be resumed from the next image.

Adding Images to a Photobook

Photobooks can be set up on the camera by choosing up to 998 images on a memory card and importing them into the included software on your computer, where they are stored in their own folder. This is convenient when ordering printed photobooks online or printing photobooks with your own printer.

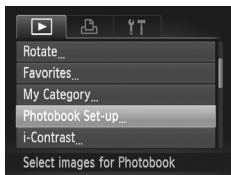
Choosing a Selection Method



- Press the **MENU** button, choose [Photobook Set-up] on the  tab, and then choose how you will select images.



-  may be displayed on the camera to warn you that the memory card has print settings that were configured on another camera. Changing the print settings using this camera may overwrite all previous settings.



- After importing images to your computer, also refer to the *ImageBrowser EX User Guide* and the printer manual for further information.

Adding Images Individually

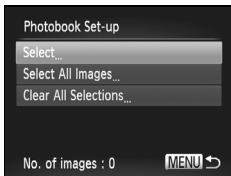

1 Choose [Select].

- Following the previous procedure, choose [Select] and press the  button.



2 Choose an image.

- Press the ◀▶ buttons to choose an image, and then press the **FUNC SET** button.
- ▶ ✓ is displayed.
- To remove the image from the photobook, press the **FUNC SET** button again. ✓ is no longer displayed.
- Repeat this process to specify other images.
- When finished, press the **MENU** button to return to the menu screen.

Adding All Images to a Photobook



1 Choose [Select All Images].

- Following the procedure on p. 192, choose [Select All Images] and press the **FUNC SET** button.

2 Configure the print settings.

- Press the ◀▶ buttons to choose [OK], and then press the **FUNC SET** button.

Removing All Images from a Photobook

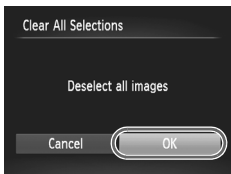

1 Choose [Clear All Selections].

- Following the procedure on p. 192, choose [Clear All Selections] and press the **FUNC SET** button.

2 Confirm clearing the photobook.

- Press the ◀▶ buttons to choose [OK], and then press the **FUNC SET** button.

Using an Eye-Fi Card

Before using an Eye-Fi card, always confirm that local use is permitted (p. 3).







Inserting a prepared Eye-Fi card enables automatic wireless transfer of images to a computer or uploading to a photo-sharing website.

Images are transferred by the Eye-Fi card. Refer to the card's user manual or contact the manufacturer for instructions on preparing and using cards or resolving transfer problems.





- When using an Eye-Fi card, keep the following points in mind.
 - Cards may continue to transmit radio waves even when [Eye-Fi trans.] is set to [Disable] (p. 195). Remove the Eye-Fi card before entering hospitals, aircraft, or other areas where transmission is prohibited.
 - When troubleshooting image transfer issues, check the card and computer settings. For details, refer to the card's user manual.
 - Poor wireless connections may cause image transfer to take a long time, and transfer may be interrupted in some cases.
 - Eye-Fi cards may become hot, due to their transfer functions.
 - Battery power will be consumed faster than in normal use.
 - Camera operation may become sluggish. To resolve this, try setting [Eye-Fi trans.] to [Disable].

Connection status of Eye-Fi cards in the camera can be checked on the shooting screen (in regular information display mode) or playback screen (in simple information display mode).

| | |
|--|---|
|  (Gray) | Not connected |
|  (Blinking white) | Connecting |
|  (White) | Connected |
|  (Animated) | Transfer in progress |
|  | Interrupted |
|  | Error acquiring Eye-Fi card information (Restart the camera. Repeated display of this icon may indicate a problem with the card.) |

Images labeled with a  icon have been transferred.





- Power saving (p. 38) on the camera is temporarily disabled during image transfer.
- Choosing  mode will interrupt the Eye-Fi connection. Although the Eye-Fi connection will be restored after you choose another shooting mode or enter Playback mode, the camera may transfer any movies made in  mode again.

Checking Connection Information

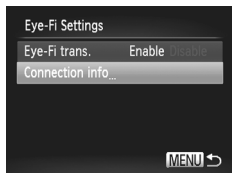
Check the access point SSID used by the Eye-Fi card or the connection status, as needed.





- Press the **MENU** button, choose [Eye-Fi Settings] on the  tab, and then press the  button.
- Choose [Connection info], and then press the  button.
- ▶ The connection information screen is displayed.

Disabling Eye-Fi Transfer

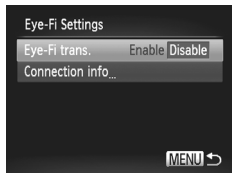
Configure the setting as follows to disable Eye-Fi transfer by the card, if necessary.



Choose [Disable] in [Eye-Fi trans.].

- Press the **MENU** button, choose [Eye-Fi Settings] on the  tab, and then press the  button.
- Choose [Eye-Fi trans.], and then choose [Disable].



- [Eye-Fi Settings] is not shown unless an Eye-Fi card is in the camera with its write-protect tab in the unlocked position. For this reason, you cannot change settings for an inserted Eye-Fi card if the write-protect tab is in the locked position.

8

Appendix

| Helpful information when using the camera

Troubleshooting

If you think there is a problem with the camera, first check the following. If the items below do not solve your problem, contact a Canon Customer Support Help Desk.

Power

Nothing happens when the ON/OFF button is pressed.

- Confirm that you are using the correct type of battery, and that there is sufficient charge (p. 205).
- Confirm that the battery is inserted facing the correct way (p. 15).
- Confirm that the memory card/battery cover is fully closed (p. 16).
- Dirty battery terminals reduce battery performance. Try cleaning the terminals with a cotton swab and reinserting the battery a few times.

The battery is depleted quickly.

- Battery performance decreases at low temperatures. Try warming the battery a little by putting it in your pocket, for example, with the terminal cover on.
- If these measures do not help and the battery is still depleted soon after charging, it has reached the end of its life. Purchase a new battery.

The lens is not retracted.

- Do not open the memory card/battery cover while the camera is on. Close the cover, turn the camera on, and then turn it off again (p. 16).

The battery is swollen.

- Battery swelling is normal and does not pose any safety concerns. However, if battery swelling prevents the battery from fitting in the camera, contact a Canon Customer Support Help Desk.

Display on a TV

Camera images look distorted or not displayed on a TV (p. 176).

Shooting

Cannot shoot.

- In Playback mode (p. 19), press the shutter button halfway (p. 39).

Strange display on the screen under low light (p. 40).

Strange display on the screen when shooting.

Note that the following display problems are not recorded in still images but are recorded in movies.

- The screen may flicker and horizontal banding may appear under fluorescent or LED lighting.

⚡ flashes on the screen when the shutter button is pressed, and shooting is not possible (p. 49).

is displayed when the shutter button is pressed halfway (p. 58).

- Set [IS mode] to [Continuous] (p. 123).
- Set the flash mode to  (p. 121).
- Increase the ISO speed (p. 108).
- Mount the camera on a tripod or take other measures to keep it still. In this case, set [IS Mode] to [Off] (p. 123).

Shots are out of focus.

- Press the shutter button halfway to focus on subjects before pressing it all the way down to shoot (p. 39).
- Make sure subjects are within focusing range (see “Specifications” (p. 32)).
- Set [AF-assist Beam] to [On] (p. 79).
- Confirm that unneeded functions such as macro are deactivated.
- Try shooting with focus lock or AF lock (pp. 119, 120).

No AF frames are displayed and the camera does not focus when the shutter button is pressed halfway.

- To have AF frames displayed and the camera focus correctly, try composing the shot with higher-contrast subject areas centered before you press the shutter button halfway. Otherwise, try pressing the shutter button halfway repeatedly.

Subjects in shots look too dark.

- Set the flash mode to  (p. 121).
- Adjust brightness by using exposure compensation (p. 107).
- Adjust contrast by using i-Contrast (pp. 109, 155).
- Use spot metering or AE lock (pp. 107, 108).

Subjects look too bright, highlights are washed-out.

- Set the flash mode to  (p. 58).
- Adjust brightness by using exposure compensation (p. 107).
- Use spot metering or AE lock (pp. 107, 108).
- Reduce the lighting on subjects.

Shots look too dark despite the flash firing (p. 49).

- Shoot within flash range (see “Specifications” (p. 32)).
- Increase the ISO speed (p. 108).

Subjects in flash shots look too bright, highlights are washed-out.

- Shoot within flash range (see “Specifications” (p. 32)).
- Set the flash mode to  (p. 58).

White dots or similar image artifacts appear in flash shots.

- This is caused by light from the flash reflecting off dust or airborne particles.

Shots look grainy.

- Lower the ISO speed (p. 108).
- High ISO speeds in some shooting modes may cause grainy images (p. 83).

Subjects are affected by red-eye (p. 73).

- Set [Red-Eye Lamp] to [On] (p. 79) to activate the red-eye reduction lamp (p. 4) in flash shots. Note that while the red-eye reduction lamp is on (for about one second), it is not possible to shoot, because the lamp is counteracting red-eye. For best results, have subjects look at the red-eye reduction lamp. Also try increasing the lighting in indoor scenes and shooting at closer range.
- Edit images using red-eye correction (p. 156).

Recording to the memory card takes too long, or continuous shooting is slower.

- Use the camera to perform low-level formatting of the memory card (p. 165).

Shooting settings or FUNC. menu settings are not available.

- Available setting items vary by shooting mode. Refer to “Functions Available in Each Shooting Mode”, “FUNC. Menu”, and “Shooting Menu” (pp. 208 – 213).

The Babies or Children icon does not display.

- The Babies and Children icons will not display if the birthday is not set in face information (p. 61). If the icons still do not display even when you set the birthday, re-register face information (p. 67), or make sure that the date/time are set correctly (p. 17).

Shooting Movies

The elapsed time shown is incorrect, or recording is interrupted.

- Use the camera to format the memory card, or switch to a card that supports high-speed recording. Note that even if the elapsed time display is incorrect, the length of movies on the memory card corresponds to the actual recording time (p. 164).

! is displayed and shooting stops automatically.

The camera's internal memory buffer filled up as the camera could not record to the memory card quickly enough. Try one of the following measures.

- Use the camera to perform low-level formatting of the memory card (p. 165).
- Lower the image quality (p. 75).
- Switch to a memory card that supports high-speed recording (see “Specifications” (p. 32)).

Subjects look distorted.

- Subjects that pass in front of the camera quickly may look distorted. This is not a malfunction.

Playback

Playback is not possible.

- Image or movie playback may not be possible if a computer is used to rename files or alter the folder structure. Refer to the *ImageBrowser EX User Guide* for details on folder structure and file names.

Playback stops, or audio skips.





- Switch to a memory card that you have performed low-level formatting on with the camera (p. 165).

- There may be brief interruptions when playing movies copied to memory cards that have slow read speeds.
- When movies are played on a computer, frames may be dropped and audio may skip if computer performance is inadequate.

Computer

Cannot transfer images to a computer.

When attempting to transfer images to the computer via a cable, try reducing the transfer speed as follows.

- Press the  button to enter Playback mode. Hold the **MENU** button down as you press the  and  buttons at the same time. On the next screen, press the  buttons to choose [B], and then press the  button.

Eye-Fi Cards

Cannot transfer images (p. 194).

Handling Precautions

- The camera is a high-precision electronic device. Avoid dropping it or subjecting it to strong impact.
- Never bring the camera near magnets, motors, or other devices that generate strong electromagnetic fields, which may cause malfunction or erase image data.
- If water droplets or dirt adheres to the camera or screen, wipe with a dry soft cloth, such as an eyeglass cloth. Do not rub hard or apply force.
- Never use cleaners containing organic solvents to clean the camera or screen.
- Use a blower brush to remove dust from the lens. If cleaning is difficult, contact a Canon Customer Support Help Desk.
- To prevent condensation from forming on the camera after sudden temperature changes (when the camera is transferred from cold to warm environments), put the camera in an airtight, resealable plastic bag and let it gradually adjust to the temperature before removing it from the bag.
- If condensation does form on the camera, stop using it immediately. Continuing to use the camera in this state may damage it. Remove the battery and memory card, and wait until the moisture has evaporated before resuming use.

On-Screen Messages

If an error message is displayed, respond as follows.

No memory card

- The memory card may be inserted facing the wrong way. Reinsert the memory card facing the correct way (p. 16).

Memory card locked

- The write-protect tab of the SD/SDHC/SDXC memory card or Eye-Fi card is set to the locked position. Switch the write-protect tab to the unlocked position (p. 15).

Cannot record!

- Shooting was attempted without a memory card in the camera. To shoot, insert a memory card facing the correct way (p. 16).

Memory card error (p. 165)

- If the same error message is displayed even when you have inserted a formatted memory card facing the correct way, contact a Canon Customer Support Help Desk (p. 16).

Insufficient space on card

- There is not enough free space on the memory card to shoot (pp. 45, 81, 105) or edit images (pp. 152 – 156). Either erase unneeded images (p. 143) or insert a memory card with enough free space (p. 15).

Change the battery pack. (p. 15)

No Image.

- The memory card does not contain any images that can be displayed.

Protected! (p. 139)

Unidentified Image/Incompatible JPEG/Image too large./Cannot play back AVI/RAW

- Unsupported or corrupt images cannot be displayed.
- It may not be possible to display images that were edited or renamed on a computer, or images shot with another camera.

Cannot magnify!/Cannot play back this content in Smart Shuffle/Cannot rotate/Cannot modify image/Cannot register this image!/Cannot modify/ Cannot assign to category/Unselectable image/No identification information.

- The following functions may be unavailable for images that were renamed or already edited on a computer, or images shot with another camera. Note that starred (*) functions are not available for movies.
Edit ID Info* (pp. 133 – 134), Magnify* (p. 135), Smart Shuffle* (p. 137), Categorize (p. 148), Rotate (p. 146), Edit* (pp. 152 – 156), Assign as Start-up Image* (p. 163), Print List* (p. 188), and Photobook Set-up* (p. 192).
- Grouped images cannot be processed (p. 100).

Invalid selection range

- When specifying a range for image selection (pp. 141, 144, 151, 190), you attempted to choose an initial image that was after the final image, or vice-versa.

Exceeded selection limit

- More than 998 images were selected for Print List (p. 188) or Photobook Set-up (p. 192). Choose 998 images or less.
- Print List (p. 188) or Photobook Set-up (p. 192) settings could not be saved correctly. Reduce the number of selected images and try again.
- You attempted to choose more than 500 images in Protect (p. 139), Erase (p. 143), Favorites (p. 148), My Category (p. 149), Print List (p. 188), or Photobook Set-up (p. 192).

Communication error

- An excessive amount of images (approx. 1,000) on the memory card prevented printing or image transfer to a computer. To transfer the images, use a commercially available USB card reader. To print, insert the memory card directly into the printer card slot.

Naming error!

- When the highest folder number (999), and the highest image number (9999) has been reached, new folders cannot be created, and images cannot be recorded. In the **↑↑** menu, change [File Numbering] to [Auto Reset] (p. 165), or format the memory card (p. 164).

Lens Error

- This error may occur if the lens is held while it is moving, or when the camera is used in dusty or sandy locations.
- Frequent display of this error message may indicate camera damage. In this case, contact a Canon Customer Support Help Desk.

A camera error was detected (error number)

- If this error message is displayed immediately after a shot, the image may not have been saved. Switch to Playback mode to check for the image.
- Frequent display of this error message may indicate camera damage. In this case, write down the error number (*Exx*) and contact a Canon Customer Support Help Desk.

File Error

- It may not be possible to print computer-edited images or images shot with another camera.

Print error

- Check the paper size setting. If this error message is displayed when the setting is correct, restart the printer and complete the setting on the camera again.



Ink absorber full

- Contact a Canon Customer Support Help Desk to request assistance with ink absorber replacement.

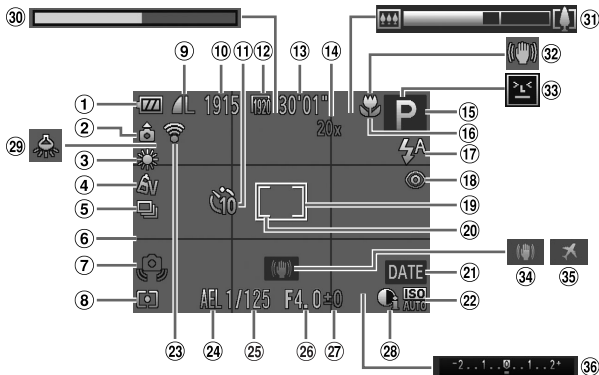
Shooting (Information Display)



- | | | |
|----------------------------|----------------------------|--------------------------------|
| ① Battery level (p. 205) | ⑭ Digital zoom | ⑳ AE lock (p. 107), FE lock |
| ② Camera orientation* | magnification (p. 55), | (p. 122) |
| ③ White balance (p. 110) | Digital tele-converter | ㉕ Shutter speed |
| ④ My Colors (p. 112) | (p. 115) | ㉖ Aperture value |
| ⑤ Drive mode (pp. 52, | ⑮ Shooting mode (p. 208), | ㉗ Exposure compensation |
| 113) | Scene icon (p. 51) | level (p. 107) |
| ⑥ Grid lines (p. 76) | ⑯ Focusing range | ㉘ i-Contrast (p. 109) |
| ⑦ Camera shake warning | (pp. 114, 115), AF lock | ㉙ Mercury lamp correction |
| (p. 49) | (p. 120) | (p. 74) |
| ⑧ Metering method | ⑰ Flash mode (pp. 58, 121) | ⑳ Super slow motion movie |
| (p. 108) | (p. 73) | (shooting time) (p. 103) |
| ⑨ Compression | ⑱ AF frame (p. 116) | ㉑ Zoom bar (p. 46) |
| (image quality) (p. 123) / | ㉒ Spot AE point frame | ㉒ Image stabilization icon |
| Resolution (p. 72) | (p. 108) | (p. 53) |
| ⑩ Recordable shots | ㉓ Date stamp (p. 59) | ㉓ Blink detection (p. 78) |
| ⑪ Self-timer (p. 56) | ㉔ ISO speed (p. 108) | ㉔ Image stabilization (p. 123) |
| ⑫ Movie quality (p. 75) | ㉕ Eye-Fi connection status | ㉕ Time zone (p. 168) |
| ⑬ Remaining time | (p. 194) | ㉖ Exposure compensation |
| | | bar |



*  : Regular orientation,   : Held vertically

The camera detects the shooting orientation and adjusts settings for optimal shots. Orientation is also detected during playback, and in either orientation, the camera automatically rotates images as needed.

However, the orientation may not be detected correctly when the camera is pointed straight up or down.

Battery Level

An on-screen icon or message indicates the battery charge level.

| Display | Details |
|--|---|
|  | Sufficient charge |
|  | Slightly depleted, but sufficient |
|  (Blinking red) | Nearly depleted – charge the battery soon |
| [Change the battery pack.] | Depleted – charge the battery immediately |

Playback (Detailed Information Display)

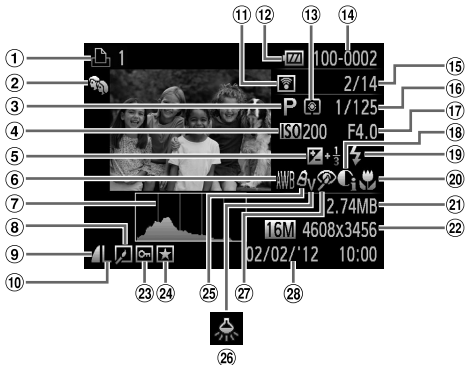













- | | | |
|--|--|--|
| ① Movies (pp. 46, 126), High-speed burst (p. 100), Print list (p. 188) | ⑩ Resolution (pp. 72, 75), MOV (movies) | ⑲ Flash (p. 121) |
| ② My Category (p. 149) | ⑪ Transferred via Eye-Fi (p. 194) | ⑳ Focusing range (pp. 114, 115) |
| ③ Shooting mode (p. 208) | ⑫ Battery level (p. 205) | ㉑ File size (p. 75) |
| ④ ISO speed (p. 108), Playback speed (pp. 89, 103) | ⑬ Metering method (p. 108) | ㉒ Still images: Resolution Movies: Movie length |
| ⑤ Exposure compensation level (p. 107) | ⑭ Folder number - File number (p. 165) | ㉓ Protection (p. 139) |
| ⑥ White balance (p. 110) | ⑮ Current image no. / Total no. of images | ㉔ Favorite (p. 148) |
| ⑦ Histogram (p. 128) | ⑯ Shutter speed (still images), Image quality / Frame rate (movies) (p. 75) | ㉕ My Colors (pp. 112, 154) |
| ⑧ Group playback (p. 132), Image editing (pp. 152 – 156) | ⑰ Aperture value | ㉖ Mercury lamp correction (p. 74) |
| ⑨ Compression ratio (image quality) (p. 123) | ⑱ i-Contrast (pp. 109, 155) | ㉗ Red-eye correction (pp. 73, 156) |
| | | ㉘ Shooting date/time (p. 17) |



Some information may not be displayed when viewing images on a TV (p. 175).

Summary of Movie Control Panel in “Viewing” (p. 126)

| | |
|---|---|
|  | Exit |
|  | Play |
|  | Slow Motion (Press the ◀▶ buttons to adjust the playback speed. No sound is played.) |
|  | Skip Backward* (To continue skipping backward, keep holding down the  button.) |
|  | Previous Frame (For fast-rewind, keep holding down the  button.) |
|  | Next Frame (For fast-forward, keep holding down the  button.) |
|  | Skip Forward* (To continue skipping forward, keep holding down the  button.) |
|  | Edit (p. 157) |
|  | Shown when the camera is connected to a PictBridge-compatible printer (p. 181). |













* Displays the frame approx. 4 sec. before or after the current frame.





• To skip forward or back during movie playback, press the ◀▶ buttons.

Functions and Menu Tables



















Functions Available in Each Shooting Mode

| Function | Shooting Mode |  | | | | | | |
|----------------------------------|---|---|---|---|---|---|---|---|
| | | AUTO | P |  |  |  |  |  |
| Exposure Compensation (p. 107) | | – | ○ | ○ | ○ | ○ | ○ | ○ |
| AE Lock/FE Lock*1 (pp. 107, 122) | | – | ○ | ○ | – | – | – | – |
| Focusing Range (pp. 114, 115) |  | ○ | ○ | ○ | ○ | ○ | ○ | ○ |
| |  | – | ○ | ○ | ○ | ○ | – | – |
| Tracking AF (p. 60) | | ○ | ○ | – | ○ | – | – | – |
| Flash (pp. 58, 121) |  | ○ | ○ | ○ | ○ | ○ | ○ | ○ |
| |  | – | ○ | ○ | ○ | ○ | ○ | ○ |
| |  | *2 | ○ | ○ | – | – | – | – |
| |  | ○ | ○ | ○ | ○ | ○ | ○ | ○ |
| AF Lock (p. 120) | | – | ○ | ○ | – | – | – | – |
| Screen Display (p. 40) | No Information Display | ○ | ○ | ○ | ○ | – | – | – |
| | Information Display | ○ | ○ | ○ | ○ | ○ | ○ | ○ |

*1 FE lock not available in  flash mode.





















































*2 Not available, but switches to  in some cases.

*3 Not available, but switches to  when the flash fires.

|  | | | | | | | | | | | | | | | | | |
|---|---|---|---|---|---|---|---|---|---|---|---|---|---|---|---|---|---|
|  |  |  |  |  |  |  |  |  |  |  |  |  |  |  |  |  |  |
| ○ | ○ | ○ | ○ | ○ | ○ | ○ | ○ | ○ | ○ | – | – | ○ | ○ | – | ○ | – | – |
| – | – | – | – | – | – | – | – | – | – | – | – | – | – | – | – | – | – |
| ○ | ○ | ○ | ○ | ○ | ○ | ○ | ○ | ○ | ○ | ○ | ○ | ○ | ○ | ○ | ○ | ○ | ○ |
| ○ | ○ | ○ | ○ | ○ | ○ | ○ | ○ | ○ | ○ | ○ | ○ | ○ | ○ | ○ | ○ | ○ | ○ |
| ○ | – | ○ | – | – | – | – | ○ | ○ | ○ | ○ | ○ | ○ | ○ | – | – | – | – |
| – | – | ○ | ○ | ○ | ○ | ○ | ○ | ○ | ○ | ○ | ○ | ○ | – | – | – | – | – |
| – | – | – | ○ | ○ | ○ | ○ | ○ | ○ | ○ | ○ | ○ | ○ | ○ | ○ | ○ | – | – |
| – | – | – | – | – | – | – | – | – | – | – | – | – | *3 | ○ | – | – | – |
| ○ | ○ | ○ | ○ | ○ | ○ | ○ | ○ | ○ | ○ | ○ | ○ | ○ | ○ | ○ | ○ | ○ | ○ |
| – | – | – | – | – | – | – | – | – | – | – | – | – | ○ | – | – | – | – |
| ○ | ○ | ○ | – | – | – | – | – | ○ | ○ | – | ○ | ○ | ○ | – | ○ | ○ | ○ |
| ○ | ○ | ○ | ○ | ○ | ○ | ○ | ○ | ○ | ○ | ○ | ○ | ○ | ○ | ○ | ○ | ○ | ○ |



○ Available or set automatically. – Not available.

FUNC. Menu

| Function | | Shooting Mode | | | | |  | | | |
|---|--|---------------|---|---|---|---|---|---|---|---|
| | | AUTO | P |  |  |  |  |  |  |  |
| Metering Method (p. 108) |  | ○ | ○ | ○ | ○ | ○ | ○ | ○ | ○ | ○ |
| |  | – | ○ | ○ | – | – | – | – | – | – |
| My Colors (p. 112) |  | ○ | ○ | ○ | ○ | ○ | ○ | ○ | ○ | ○ |
| |     *1 | – | ○ | ○ | – | – | ○ | ○ | ○ | ○ |
| |  *1        *2 | – | ○ | ○ | – | – | ○ | ○ | ○ | ○ |
| White Balance (p. 110) | AWB | ○ | ○ | ○ | ○ | ○ | ○ | ○ | ○ | ○ |
| |      | – | ○ | ○ | – | – | ○ | ○ | ○ | ○ |
| |  *3 | – | ○ | ○ | – | – | ○ | ○ | ○ | ○ |
| Underwater White Balance Compensation (p. 84) | | – | – | – | – | – | – | – | – | – |
| ISO Speed (p. 108) |  AUTO | ○ | ○ | ○ | ○ | ○ | ○ | ○ | ○ | ○ |
| |       | – | ○ | ○ | – | – | – | – | – | – |
| Self-Timer (pp. 56, 57) |  | ○ | ○ | ○ | ○ | ○ | ○ | ○ | ○ | ○ |
| |    | ○ | ○ | ○ | ○ | ○ | – | – | – | – |
| Self-Timer Settings (p. 57) | Delay*4 | ○ | ○ | ○ | ○ | ○ | – | – | – | – |
| | Shots*5 | ○ | ○ | – | ○ | ○ | – | – | – | – |
| Drive Mode (p. 113) |  | ○ | ○ | ○ | ○ | ○ | ○ | ○ | ○ | ○ |
| |  | ○ | – | – | – | – | – | – | – | – |
| Still Image Aspect Ratio (p. 71) |    | – | ○ | ○ | – | ○ | – | ○ | ○ | ○ |
| |  | ○ | ○ | ○ | ○ | ○ | ○ | ○ | ○ | ○ |
| Resolution (p. 72) | L | ○ | ○ | ○ | ○ | ○ | ○ | ○ | ○ | ○ |
| | M1 M2 | ○ | ○ | ○ | ○ | ○ | – | ○ | ○ | ○ |
| | M | – | – | – | – | – | – | – | – | – |
| Compression (p. 123) | S | ○ | ○ | ○ | ○ | ○ | – | ○ | ○ | ○ |
| |  | ○ | ○ | ○ | ○ | ○ | ○ | ○ | ○ | ○ |
| Movie Quality (p. 75) |  | ○ | ○ | ○ | ○ | ○ | ○ | ○ | ○ | ○ |
| |  | ○ | ○ | ○ | ○ | ○ | ○ | ○ | ○ | ○ |
| |  | ○ | ○ | ○ | ○ | ○ | ○ | ○ | ○ | ○ |
| |   | – | – | – | – | – | – | – | – | – |



















*1 White balance is not available.

*2 Set in a range of 1 – 5: contrast, sharpness, color saturation, red, green, blue, and skin tone.

 *3 Not available in  or .

*4 Cannot be set to 0 seconds in modes without selection of the number of shots.

*5 One shot (cannot be modified) in modes without selection of the number of shots.

|  | | | | | | | | | | | | | | | | | |
|---|---|---|---|---|---|---|---|---|---|---|---|---|---|---|---|---|---|
|  |  |  |  |  |  |  |  |  |  |  |  |  |  |  |  |  |  |
| ○ | ○ | ○ | ○ | ○ | ○ | ○ | ○ | ○ | ○ | ○ | ○ | ○ | ○ | ○ | ○ | ○ | ○ |
| - | - | - | - | - | - | - | - | - | - | - | - | - | - | - | - | - | - |
| ○ | ○ | ○ | ○ | ○ | ○ | ○ | ○ | ○ | ○ | ○ | ○ | ○ | ○ | ○ | ○ | ○ | ○ |
| - | - | - | - | - | - | - | - | - | - | - | - | - | ○ | ○ | ○ | - | - |
| ○ | ○ | ○ | ○ | ○ | ○ | ○ | ○ | ○ | ○ | ○ | ○ | ○ | ○ | ○ | ○ | ○ | ○ |
| ○ | - | ○ | - | - | - | - | - | - | - | - | - | - | - | ○ | ○ | ○ | - |
| ○ | - | ○ | - | - | - | - | - | - | - | - | - | - | ○ | - | ○ | ○ | - |
| - | - | - | - | - | - | - | - | - | - | - | - | ○ | - | - | - | - | - |
| ○ | ○ | ○ | ○ | ○ | ○ | ○ | ○ | ○ | ○ | ○ | ○ | ○ | ○ | ○ | ○ | ○ | ○ |
| - | - | - | - | - | - | - | - | - | - | - | - | - | - | - | - | - | - |
| ○ | ○ | ○ | ○ | ○ | ○ | ○ | ○ | ○ | ○ | ○ | ○ | ○ | ○ | ○ | ○ | ○ | ○ |
| - | ○ | ○ | ○ | ○ | ○ | ○ | ○ | ○ | ○ | ○ | ○ | ○ | ○ | ○ | ○ | ○ | ○ |
| - | ○ | ○ | ○ | ○ | ○ | ○ | ○ | ○ | ○ | ○ | ○ | ○ | ○ | ○ | ○ | ○ | ○ |
| - | ○ | ○ | ○ | ○ | ○ | ○ | ○ | ○ | ○ | ○ | ○ | ○ | ○ | ○ | ○ | ○ | ○ |
| - | - | - | - | - | - | - | - | - | - | - | - | - | - | - | - | - | - |
| ○ | - | ○ | ○ | ○ | ○ | ○ | ○ | ○ | ○ | ○ | ○ | ○ | ○ | - | - | - | - |
| - | - | - | - | *6 | - | - | ○ | ○ | ○ | ○ | ○ | ○ | ○ | ○ | - | - | - |
| - | ○ | - | ○ | ○ | ○ | ○ | ○ | ○ | ○ | ○ | ○ | ○ | ○ | ○ | ○ | ○ | ○ |
| - | - | - | - | - | - | - | - | - | - | - | - | ○ | ○ | ○ | ○ | ○ | ○ |
| ○ | - | ○ | - | - | - | - | - | - | - | - | - | - | - | - | - | - | - |
| - | - | - | - | - | - | - | - | - | - | - | - | ○ | ○ | ○ | ○ | ○ | ○ |
| - | - | - | - | - | - | - | - | - | - | - | - | - | - | - | - | - | - |
| ○ | ○ | ○ | ○ | ○ | ○ | ○ | ○ | ○ | ○ | ○ | ○ | ○ | ○ | ○ | ○ | ○ | ○ |
| ○ | ○ | ○ | ○ | - | ○ | ○ | ○ | ○ | ○ | ○ | ○ | ○ | ○ | ○ | ○ | ○ | - |
| ○ | ○ | ○ | ○ | *7 | ○ | ○ | ○ | ○ | ○ | ○ | ○ | ○ | ○ | ○ | ○ | ○ | - |
| ○ | ○ | ○ | ○ | *7 | ○ | ○ | ○ | ○ | ○ | ○ | ○ | ○ | ○ | ○ | ○ | ○ | - |
| - | - | - | - | - | - | - | - | - | - | - | - | - | - | - | - | - | ○ |

*6 Only 4:3 and 16:9 are available.

○ Available or set automatically. - Not available.

*7 Synchronizes with the aspect ratio setting and is automatically set (p. 89).

Shooting Menu



















| Function | | Shooting Mode | | | | | | | |
|-----------------------------|------------------------------------|---------------|---|---|---|---|---|---|---|
| | | AUTO | P | | | | | | |
| AF Frame (p. 116) | Face AiAF*1 | ○ | ○ | ○ | ○ | ○ | ○ | ○ | ○ |
| | Tracking AF | *2 | ○ | – | ○ | – | – | – | – |
| | Center | – | ○ | ○ | ○ | – | – | – | – |
| AF Frame Size*3 (p. 118) | Normal | – | ○ | ○ | ○ | – | – | – | – |
| | Small | – | ○ | ○ | ○ | – | – | – | – |
| | Standard | ○ | ○ | – | ○ | – | ○ | ○ | ○ |
| Digital Zoom (p. 55) | Off | ○ | ○ | ○ | ○ | ○ | ○ | ○ | ○ |
| | Digital Tele-converter (1.6x/2.0x) | – | ○ | – | – | – | – | – | – |
| | On | ○ | ○ | – | ○ | – | ○ | ○ | ○ |
| AF-Point Zoom (p. 77) | Off | ○ | ○ | ○ | ○ | ○ | ○ | ○ | ○ |
| | On | – | ○ | – | ○ | – | – | – | – |
| Servo AF (p. 119) | Off*4 | ○ | ○ | ○ | ○ | ○ | ○ | ○ | ○ |
| | On | ○ | ○ | ○ | ○ | ○ | ○ | ○ | ○ |
| AF-assist Beam (p. 79) | Off | ○ | ○ | ○ | ○ | ○ | ○ | ○ | ○ |
| | On | ○ | ○ | ○ | ○ | ○ | ○ | ○ | ○ |
| Flash Settings (pp. 73, 79) | Red-Eye Corr. | On | ○ | ○ | ○ | ○ | – | ○ | ○ |
| | | Off | ○ | ○ | ○ | ○ | ○ | ○ | ○ |
| | Red-Eye Lamp | On/Off | ○ | ○ | ○ | ○ | ○ | ○ | ○ |
| i-Contrast (p. 109) | Auto | ○ | ○ | ○ | – | – | – | – | – |
| | Off | – | ○ | ○ | ○ | ○ | ○ | ○ | ○ |
| Hg Lamp Corr. (p. 74) | On/Off | ○ | – | – | – | – | – | – | – |
| Review (p. 80) | Off/2 – 10 sec./Hold | ○ | ○ | ○ | ○ | ○ | ○ | ○ | ○ |
| Review Info (p. 80) | Off | ○ | ○ | ○ | ○ | ○ | ○ | ○ | ○ |
| | Detailed/Focus Check | ○ | ○ | ○ | ○ | ○ | ○ | ○ | ○ |
| Blink Detection (p. 78) | On | ○ | ○ | ○ | ○ | ○ | ○ | ○ | ○ |
| | Off | ○ | ○ | ○ | ○ | ○ | ○ | ○ | ○ |
| Grid Lines (p. 76) | On | ○ | ○ | ○ | ○ | ○ | ○ | ○ | ○ |
| | Off | ○ | ○ | ○ | ○ | ○ | ○ | ○ | ○ |
| IS Settings (p. 123) | IS Mode | Off | ○ | ○ | ○ | ○ | ○ | ○ | ○ |
| | | Continuous | ○ | ○ | ○ | ○ | ○ | ○ | ○ |
| | | Shoot Only | – | ○ | – | ○ | ○ | ○ | ○ |
| | Powered IS | On | ○ | ○ | ○ | ○ | ○ | ○ | ○ |
| Off | | ○ | ○ | ○ | ○ | ○ | ○ | ○ | |
| Date Stamp (p. 59) | Off | ○ | ○ | ○ | ○ | ○ | ○ | ○ | |
| | Date/Date & Time | ○ | ○ | ○ | ○ | – | ○ | ○ | |
| Face ID Settings (p. 61) | | ○ | ○ | ○ | ○ | ○ | ○ | ○ | |

*1 Operation when no faces are detected varies by shooting mode.







*2 Only available by pressing the button (p. 60).

*3 Available when the AF frame is set to [Center].

*4 [On] when subject movement is detected in mode.

|  | | | | | | | | | | | | | | | | |
|---|---|---|---|---|---|---|---|---|---|---|---|---|---|---|---|---|
|  |  |  |  |  |  |  |  |  |  |  |  |  |  |  |  |  |
| ○ | ○ | ○ | - | - | ○ | ○ | ○ | ○ | ○ | ○ | - | ○ | ○ | - | ○ | ○ |
| ○ | - | ○ | - | - | - | - | ○ | ○ | ○ | ○ | ○ | ○ | ○ | - | - | - |
| ○ | - | ○ | ○ | - | ○ | ○ | ○ | ○ | ○ | ○ | ○ | ○ | ○ | ○ | ○ | ○ |
| ○ | - | ○ | - | - | ○ | ○ | ○ | ○ | ○ | ○ | ○ | ○ | ○ | - | ○ | ○ |
| - | - | - | - | - | - | - | - | - | - | - | ○ | ○ | ○ | - | ○ | - |
| ○ | ○ | ○ | ○ | ○ | ○ | ○ | ○ | ○ | ○ | ○ | ○ | ○ | ○ | ○ | ○ | ○ |
| - | - | - | - | - | - | - | - | - | - | - | - | - | - | - | - | - |
| ○ | - | ○ | - | - | - | - | ○ | ○ | ○ | ○ | ○ | ○ | ○ | - | - | - |
| ○ | ○ | ○ | ○ | ○ | ○ | ○ | ○ | ○ | ○ | ○ | ○ | ○ | ○ | ○ | ○ | ○ |
| - | - | ○ | - | - | - | - | ○ | ○ | ○ | ○ | ○ | ○ | ○ | - | - | - |
| ○ | ○ | ○ | ○ | ○ | ○ | ○ | ○ | ○ | ○ | ○ | ○ | ○ | ○ | ○ | ○ | ○ |
| ○ | ○ | ○ | ○ | ○ | ○ | ○ | ○ | ○ | ○ | ○ | ○ | ○ | ○ | ○ | ○ | ○ |
| - | - | ○ | - | - | - | - | - | - | - | - | - | ○ | ○ | - | - | - |
| ○ | ○ | ○ | ○ | ○ | ○ | ○ | ○ | ○ | ○ | ○ | ○ | ○ | ○ | ○ | ○ | ○ |
| ○ | ○ | ○ | ○ | ○ | ○ | ○ | ○ | ○ | ○ | ○ | ○ | ○ | ○ | ○ | ○ | ○ |
| ○ | ○ | ○ | ○ | ○ | ○ | ○ | ○ | ○ | ○ | ○ | ○ | ○ | ○ | ○ | ○ | ○ |
| ○ | - | ○ | - | - | - | - | - | - | - | - | - | - | - | - | - | - |
| ○ | - | ○ | - | ○ | ○ | ○ | ○ | ○ | ○ | ○ | ○ | - | ○ | ○ | ○ | - |
| - | - | - | - | - | - | - | - | - | - | - | - | - | - | - | - | - |
| ○ | ○ | ○ | ○ | ○ | ○ | ○ | ○ | ○ | ○ | ○ | ○ | ○ | ○ | ○ | - | - |
| ○ | ○ | ○ | ○ | ○ | ○ | ○ | ○ | ○ | ○ | ○ | ○ | ○ | ○ | ○ | - | - |
| ○ | ○ | ○ | ○ | ○ | ○ | ○ | ○ | ○ | ○ | ○ | ○ | ○ | ○ | ○ | ○ | ○ |
| ○ | ○ | ○ | ○ | ○ | ○ | ○ | ○ | ○ | ○ | ○ | ○ | ○ | ○ | ○ | ○ | ○ |
| ○ | ○ | ○ | ○ | ○ | ○ | ○ | ○ | ○ | ○ | ○ | ○ | ○ | ○ | ○ | ○ | ○ |
| ○ | ○ | ○ | ○ | ○ | ○ | ○ | ○ | ○ | ○ | ○ | ○ | ○ | ○ | ○ | ○ | ○ |
| ○ | - | ○ | ○ | ○ | ○ | ○ | ○ | ○ | ○ | ○ | ○ | ○ | ○ | ○ | - | - |
| ○ | ○ | ○ | ○ | ○ | ○ | ○ | ○ | ○ | ○ | ○ | ○ | ○ | ○ | ○ | ○ | ○ |
| ○ | - | ○ | ○ | ○ | ○ | ○ | ○ | ○ | ○ | ○ | ○ | ○ | ○ | ○ | ○ | ○ |
| ○ | ○ | ○ | ○ | ○ | ○ | ○ | ○ | ○ | ○ | ○ | ○ | ○ | ○ | ○ | ○ | ○ |
| - | - | - | - | - | - | - | - | - | - | - | ○ | ○ | ○ | - | - | - |
| ○ | ○ | ○ | ○ | ○ | ○ | ○ | ○ | ○ | ○ | ○ | ○ | ○ | ○ | ○ | ○ | ○ |

○ Available or set automatically. - Not available.

- When using [Face ID] (p. 61) to shoot, names will not be displayed in , , , , or , but they will be recorded in still images.
- Setting available, but when using [Face ID] (p. 61) to shoot, names will not be displayed in  or , and they will not be recorded in movies.

Set up Menu

| Item | Ref. Page |
|----------------|--------------|
| Mute | p. 160 |
| Volume | p. 160 |
| Sound Options | p. 161 |
| Hints & Tips | p. 161 |
| LCD Brightness | p. 162 |
| Start-up Image | p. 162 |
| Format | pp. 164, 165 |
| File Numbering | p. 165 |
| Create Folder | p. 166 |

| Item | Ref. Page |
|--|-------------|
| Lens Retract | p. 166 |
| Power Saving | pp. 38, 167 |
| Time Zone | p. 168 |
| Date/Time | p. 18 |
| Video System | p. 176 |
| Ctrl via HDMI | p. 177 |
| Eye-Fi Settings | p. 194 |
| Language  | p. 19 |
| Reset All | p. 170 |

Playback Menu

| Item | Ref. Page |
|--------------------|-----------|
| Slideshow | p. 136 |
| Erase | p. 143 |
| Protect | p. 139 |
| Rotate | p. 146 |
| Favorites | p. 148 |
| My Category | p. 149 |
| Photobook Set-up | p. 192 |
| i-Contrast | p. 155 |
| Red-Eye Correction | p. 156 |

| Item | Ref. Page |
|----------------|-----------|
| Trimming | p. 153 |
| Resize | p. 152 |
| My Colors | p. 154 |
| Face ID Info | p. 133 |
| Scroll Display | p. 127 |
| Group Images | p. 133 |
| Auto Rotate | p. 147 |
| Resume | p. 127 |
| Transition | p. 127 |

**Print Menu**

| Item | Ref. Page | Item | Ref. Page |
|----------------------|-----------|----------------------|-----------|
| Print | – | Select All Images | p. 191 |
| Select Images & Qty. | p. 190 | Clear All Selections | p. 191 |
| Select Range | p. 190 | Print Settings | p. 188 |

Playback Mode FUNC. Menu

| Item | Ref. Page | Item | Ref. Page |
|----------------|-----------|-----------------------|-----------|
| Rotate | p. 146 | Play Movie | p. 126 |
| Print List | p. 188 | Movie Digest Playback | p. 132 |
| Protect | p. 139 | Smart Shuffle | p. 137 |
| Favorites | p. 148 | Image Search | p. 130 |
| Erase | p. 143 | Slideshow | p. 136 |
| Group Playback | p. 132 | My Category | p. 149 |

A

| | |
|--------------------------------|-------------|
| AC adapter kit..... | 173, 179 |
| Accessories..... | 173 |
| AE lock..... | 107 |
| AF frames..... | 21, 47, 116 |
| AF → Focusing | |
| AF lock..... | 120 |
| Aspect ratio..... | 71 |
| AUTO mode (shooting mode)..... | 20, 46 |
| AV cable..... | 175 |

B

| | |
|-----------------------------|-----|
| Battery | |
| Charging..... | 14 |
| Level..... | 205 |
| Power saving..... | 38 |
| Battery charger..... | 173 |
| Black and white images..... | 112 |
| Blink detection..... | 78 |

C

| | |
|--|-----|
| Camera | |
| Reset all..... | 170 |
| Camera shake..... | 123 |
| Center (AF frame mode)..... | 118 |
| Clock..... | 43 |
| Color (white balance)..... | 110 |
| Color Accent (shooting mode)..... | 92 |
| Color Swap (shooting mode)..... | 93 |
| Compression ratio (image quality)..... | 123 |
| Continuous shooting..... | 113 |
| High-speed burst (shooting mode)... | 100 |
| Cropping..... | 153 |
| Custom white balance..... | 111 |

D

| | |
|-----------------------------------|-----|
| Date/time | |
| Adding date/time to images..... | 59 |
| Changing..... | 18 |
| Setting..... | 17 |
| World clock..... | 168 |
| DC coupler..... | 179 |
| Defaults → Reset all | |
| DIGITAL CAMERA Solution Disk..... | 2 |
| Digital tele-converter..... | 115 |

| | |
|-----------------------|-----|
| Digital zoom..... | 55 |
| Display language..... | 19 |
| DPOF..... | 188 |

E

| | |
|-------------------------|--------|
| Editing | |
| Cropping..... | 153 |
| i-Contrast..... | 155 |
| My Colors..... | 154 |
| Red-eye correction..... | 156 |
| Resizing images..... | 152 |
| Erasing..... | 143 |
| Erasing all..... | 143 |
| Error messages..... | 202 |
| Exposure | |
| AE lock..... | 107 |
| Compensation..... | 107 |
| FE lock..... | 122 |
| Eye-Fi cards..... | 2, 194 |

F

| | |
|--------------------------------------|----------|
| Face AiAF (AF frame mode)..... | 116 |
| Face ID..... | 61, 133 |
| Face self-timer (shooting mode)..... | 98 |
| Favorites..... | 148 |
| FE lock..... | 122 |
| File numbering..... | 165 |
| Fish-eye effect (shooting mode)..... | 87 |
| Flash | |
| Deactivating the flash..... | 58 |
| On..... | 121 |
| Slow synchro..... | 121 |
| Focus check..... | 129 |
| Focusing | |
| AF frames..... | 116 |
| AF lock..... | 120 |
| AF-point zoom..... | 77 |
| Servo AF..... | 119 |
| Focusing range | |
| Infinity..... | 115 |
| Macro..... | 114 |
| Focus lock..... | 119 |
| FUNC. menu | |
| Basic operations..... | 41 |
| Table..... | 210, 215 |

- G**
- Grid lines 76
- H**
- Handheld nightscene (shooting mode)..... 82
 High-speed burst (shooting mode)..... 100
 Household power..... 179
- I**
- i-Contrast..... 109, 155
 Image quality → Compression ratio
 Images
 Display period..... 80
 Erasing..... 143
 Playback → Viewing
 Protecting..... 139
 Indicator..... 43
 Infinity (focus mode)..... 115
 Interface cable..... 2, 181
 ISO speed..... 108
- L**
- Lamp..... 79
 Language display 19
 Long shutter (shooting mode)..... 99
 Low-light (shooting mode)..... 83
- M**
- Macro (focus mode)..... 114
 Magnified display..... 135
 Memory cards..... 2
 Menu
 Basic operations 42
 Table..... 208
 Metering method..... 108
 Miniature effect (shooting mode)..... 88
 Monochrome (shooting mode)..... 91
 Movie Digest (shooting mode)..... 95
 Movies
 Editing..... 157
 Image quality (resolution/frame rate) .. 75
 Recording time..... 33, 34
 Multi-area White Balance 74
 My Category..... 149
 My Colors 112, 154
- P**
- P (shooting mode)..... 106
 Package contents..... 2
 Photobook set-up 192
 PictBridge 174, 181
 Playback → Viewing
 Portrait (shooting mode)..... 82
 Poster effect (shooting mode) 86
 Powered IS..... 124
 Power → Battery, AC adapter kit
 Power saving..... 38
 Printing 181
 Program AE 106
 Protecting 139
- R**
- Red-eye correction 73, 156
 Reset all..... 170
 Resizing images 152
 Resolution (image size)..... 72
 Rotating 146
- S**
- Screen
 Icons 204, 206
 Language display..... 19
 Menu → FUNC. menu, Menu
 SD/SDHC/SDXC memory cards
 → Memory cards
 Self-timer 56
 2-second self-timer 57
 Customizing the self-timer 57
 Face self-timer (shooting mode)..... 98
 Wink self-timer (shooting mode)..... 97
 Sepia tone images..... 112
 Servo AF..... 119
 Shooting
 Shooting date/time → Date/time
 Shooting information..... 204
 Slideshow 136
 Smart Shuffle..... 137
 Smart Shutter (shooting mode) 96
 Smile (shooting mode)..... 96
 Smooth skin (shooting mode)..... 85
 Snow (shooting mode)..... 83

| | |
|--|-----|
| Soft focus (shooting mode) | 90 |
| Software | |
| DIGITAL CAMERA Solution Disk | 2 |
| Installation | 27 |
| Sounds | 160 |
| Stitch Assist (shooting mode)..... | 102 |
| Strap..... | 2 |
| Super slow motion movie (movie mode).. | 103 |
| Super vivid (shooting mode)..... | 86 |

T

| | |
|--|--------------------|
| Terminal | 175, 176, 179, 181 |
| Toy camera effect (shooting mode)..... | 89 |
| Tracking AF | 60, 117 |
| Traveling with the camera | 168, 172 |
| Troubleshooting..... | 198 |
| TV display..... | 175 |

U

| | |
|---------------------------------|----|
| Underwater (shooting mode)..... | 83 |
|---------------------------------|----|

V

| | |
|----------------------------|-----|
| Viewing | |
| Image search..... | 130 |
| Index display..... | 130 |
| Magnified display..... | 135 |
| Single-image display | 22 |
| Slideshow | 136 |
| Smart Shuffle..... | 137 |
| TV display..... | 175 |

W

| | |
|--------------------------------------|-----|
| White balance (color) | 110 |
| Wink self-timer (shooting mode)..... | 97 |
| World clock..... | 168 |
| Wrist strap → Strap | |

Z

| | |
|------------|------------|
| Zoom | 20, 46, 55 |
|------------|------------|

CAUTION

RISK OF EXPLOSION IF BATTERY IS REPLACED BY AN INCORRECT TYPE.
DISPOSE OF USED BATTERIES ACCORDING TO LOCAL REGULATION.

Trademark Acknowledgments

- The SDXC logo is a trademark of SD-3C, LLC.
- This device incorporates exFAT technology licensed from Microsoft.
- HDMI, the HDMI logo and High-Definition Multimedia Interface are trademarks or registered trademarks of HDMI Licensing LLC.
- The iFrame logo and the iFrame symbol are trademarks of Apple Inc.

About MPEG-4 Licensing

This product is licensed under AT&T patents for the MPEG-4 standard and may be used for encoding MPEG-4 compliant video and/or decoding MPEG-4 compliant video that was encoded only (1) for a personal and non-commercial purpose or (2) by a video provider licensed under the AT&T patents to provide MPEG-4 compliant video.

No license is granted or implied for any other use for MPEG-4 standard.

* Notice displayed in English as required.

Disclaimer

- Reprinting, transmitting, or storing in a retrieval system any part of this guide without the permission of Canon is prohibited.
- Canon reserves the right to change the contents of this guide at any time without prior notice.
- Illustrations and screenshots in this guide may differ slightly from the actual equipment.
- The above items notwithstanding, Canon accepts no liability for damages due to mistaken operation of the products.